

DISPLAY

YOUR BRAND, ANYWHERE



FLOOR VINYL'S • BANNERS • BANNERWALLS • TABLE CLOTHS • FLAGS • FLAG FOUNTAINS
POP-UP BANNERS • A-FRAME BANNERS • FLYING BANNERS • PARASOLS • GAZEBOS



DISPLAY

YOUR BRAND, ANYWHERE

CONTENTS

Indoor & Outdoor Displays _____	1
Understanding Our Ranges _____	2
Digital Branding & Reskinning _____	3 - 4
Floor Vinyls _____	5 - 6
X-Banners _____	9 - 10
Pull Up Banners _____	11 - 14
Straight Bannerwalls _____	17 - 20
Double-Sided Straight Bannerwalls _____	21 - 24
Curved Bannerwalls _____	25 - 26
Curved Bannerwalls with Wings _____	27 - 28
Table Cloths _____	29 - 32
Desk Flags _____	35
Hand Flags _____	36
Flag Fountains _____	37 - 38
Pop-Up Banners _____	40
Sublimated A-Frame Banners _____	42
Fade Resistant A-Frame Banners _____	44
Arcfin Flying Banners _____	48 - 49
Sharkfin Flying Banners _____	52 - 53
Telescopic Flying Banners _____	56 - 57
Sublimated Parasols _____	60 - 63
Fade Resistant Parasols _____	66 - 69
Sublimated Gazebos _____	70 - 83
Fade Resistant Gazebos _____	86 - 99



DISPLAY YOUR BRAND ANYWHERE

Spanning across INDOOR AND OUTDOOR products, it's simply about choosing from over 200 display solutions to suit any environment or requirement.

WHY DISPLAY?

Our display solutions provide the perfect platform to advertise your brand anywhere you choose, allowing you to generate brand awareness and market your products or services to a wide audience with ease. Display products are easy-to-assemble and transport, allowing you to instantly transform any space into a branded space.

Whether you are a newcomer trying to gain much needed brand exposure or a well-established franchise, we understand the need to make the most of your marketing budget. With the high quality, reusable nature of our display products, you can be assured of an excellent return on investment.

When choosing the ideal display solution for your business it's important to consider the environment in which you would like to predominantly use your display. For easy reference, we've classified our displays into the following categories and ranges, based on their recommended application.

INDOOR DISPLAYS

Designed for environments with low exposure to the elements, these displays are portable, lightweight, easy-to-assemble and ideal for promoting your brand in retail outlets, office parks, reception areas, forecourts and at trade shows, conferences or events.

OUTDOOR DISPLAYS

Ideal for outdoor environments these durable displays are equipped to withstand the elements. Our innovative designs will allow you to conveniently assemble, dismantle and store your display for any event. This range is suitable for brand launches, markets, sporting events, marathons, schools, festivals, golf days and so much more.

All of our displays are manufactured to the highest standards and our scientific approach ensures quality and consistency throughout. The following ranges are available and have been ranked based on their construction, hardware, materials and design features.

UNDERSTANDING OUR RANGES



CHAMPION RANGE

CHAMPION RANGE

Whether you are looking for high volumes or cost-effective display solutions - this lightweight, entry level range offers exceptional value without compromising on quality.



LEGEND RANGE

LEGEND RANGE

For increased durability, this range is constructed from slightly heavier weight materials and is impeccably finished for a more upmarket environment.



OVATION RANGE

OVATION RANGE

This range is defined by its premium quality construction and durability, for those looking for a luxurious, high-end product.



DIGITAL BRANDING

Our range of digital branding solutions, quick turnaround times, vast capacity and in-depth understanding of the complexity associated with branding displays - will ensure a world-class experience from start to finish.

HOW DOES IT WORK?

Our process utilises a specific set of digital ink technologies and state-of-the-art mechanical processes to digitally print on the carefully selected fabric and PVC substrates used in our displays. This process produces vibrant, photo-realistic results - ideal for sharp details and full colour artwork.

WHAT INKS ARE USED?

DYE SUBLIMATION INK

This process uses heat to transform the water based dye sublimation ink into a gaseous state which allows it to infuse with the substrate fibres - producing vivid results.

NEW LATEX GEN-4 INK

Our new state-of-the-art Latex Gen-4 inks, boast the widest colour gamut on the market. This allows us to print the widest range of colours within the colour spectrum and produce the most vibrant and vivid print results. Versatile in its application, this process produces low VOC emissions and offers exceptional resistance against the elements. Extremely durable and UV stable, this ink is waterproof, non-absorbent and has a high scratch resistance.



SUBSTRATES "SKINS"

The term describes the base material onto which your artwork is printed. We've specially selected the substrates for our range of displays to give you the best possible printing solution and create the perfect skin for your display.

BLOCKOUT PVC

A lightweight and resilient substrate with 100% opacity, which doesn't allow light to filter through the display - predominantly used for our A-Frame displays, ensuring maximum visibility indoors and outdoors.

LAYFLAT PVC

A durable and lightweight substrate with anti-curl properties - predominantly used for our X-Banners and Pull Up Banners, allowing you to easily roll-up and store your artwork for your next event.

SPANDEX

Our 240gsm Spandex Polyester is ideal due to its 4-way stretch properties and vibrant colour produced in the Sublimation print process. This fabric allows for a tight fit when tensioned over a trestle table, and is used for our Spandex slip over table cloths.

DISPLAY POLYESTER FABRIC

Our 230gsm Knit Polyester is ideal due to its stability during the printing process. This fabric is also crease-resistant, allowing you to easily assemble, dismantle, transport and store your display. For products that we offer with this type of fabric, you can look out for some of our Bannerwalls, Pop-Up Banners, A-Frame Banners and Table Cloths.

WARP KNIT POLYESTER

Our specially selected Polyester Warp Knit Fabric is used for our flying banners and flags due to the stability of the fabric during the printing process. This allows us to control the print gain, ensuring a high quality, sharp print.

PRINT-GUARD POLYESTER

Our premium 250gsm Print-Guard Polyester has a unique coating, which has been developed to prime the surface, assist with print adhesion, and retain flexibility - ideal for long term UV exposure.

GAZEBO DISPLAY FABRIC

240gsm Gazebo Polyester Fabric is ideal due to its stability during the direct print process. This fabric also has a 600D water head, water resistant coating and is used for our sublimated printing process option on the following displays; Gazebos, Pull-Up Banners, Parasols and X-Banners.

RESKINNING

This innovative and cost-effective solution offers a fantastic ROI for your business. Reskinning allows you to re-use your existing display hardware and order a new skin to refresh your branding when it's old and outdated or as often as you like for seasonal promotions, product launches or limited offers - the possibilities are infinite.

Please note all reskinning is specifically tailored to fit this range of hardware. It is your responsibility to ensure you are ordering the correct skin for the correct hardware. We do not guarantee fitment to 3rd party hardware.

NEW FADE RESISTANT DISPLAY RANGE

BUILT TO LAST & IDEAL FOR LONG-TERM SUN EXPOSURE

FADE RESISTANT

VS

SUBLIMATED

INKS

New Latex Gen-4 Ink

- Widest colour gamut available on the market, producing vibrant and vivid print results
- Superior print fade stability

Water Based Dye Sublimation Ink

- Standard inks that produce good, full-colour print results
- Standard print fade stability

FABRICS

Print Guard Polyester

This fabric has a unique coating, which has been developed to prime the surface, assist with print adhesion, and retain the flexibility of the print - great durability for long-term outdoor exposure.

Gazebo Display Fabric

Ideal for sublimation displays due to its stability during the printing process. This fabric is also water resistant.

USES

Ideal for restaurants, venues and outdoor facilities that require durable long-lasting displays.

Cost-effective for marketing campaigns where the display skins need to be updated frequently for seasonal promotions, events, product launches or limited offers.

LIFECYCLE

While the surface-based Latex Gen-4 ink offers great durability for long-term outdoor exposure, it's essential to be mindful of the display's intended use when considering its lifecycle. If frequent assembly and transportation will be required, it is important to note that the surface based prints on our fade-resistant displays are more susceptible to friction and scratches during regular handling, which may affect the overall longevity of the print.

The dye-sublimation process uses heat to transform the water based ink into a gaseous state, which allows it to infuse with the substrate fibres - making this solution an excellent choice for displays that require regular assembly and disassembly. These displays are well-suited for environments where frequent setup and transportation are part of the display lifecycle.

WARRANTY

2-YEAR PRINT WARRANTY*

90-DAY PRINT WARRANTY



*The 2 year print warranty does not extend to damages resulting from friction, scratches or other issues arising from frequent handling and transportation.

FLOOR VINYL

Let your brand lead the way!

Our Floor Vinyls are manufactured from high quality, anti-slip floor lamination to ensure safety for foot traffic. Vinyls are easy to apply, tough and durable, ensuring longevity of use.

This range is ideal for directional signage in large venues, retail centres, office blocks, schools and hospitals.



SQUARE FLOOR VINYL



DISPLAY-5045
Floor sticker: laminated vinyl, 30 x 30cm, durable, removable, anti-slip, self-adhesive
Branding: digital print

★★
LEGEND
 RANGE

SOLD IN SETS OF 8

ROUND FLOOR VINYL

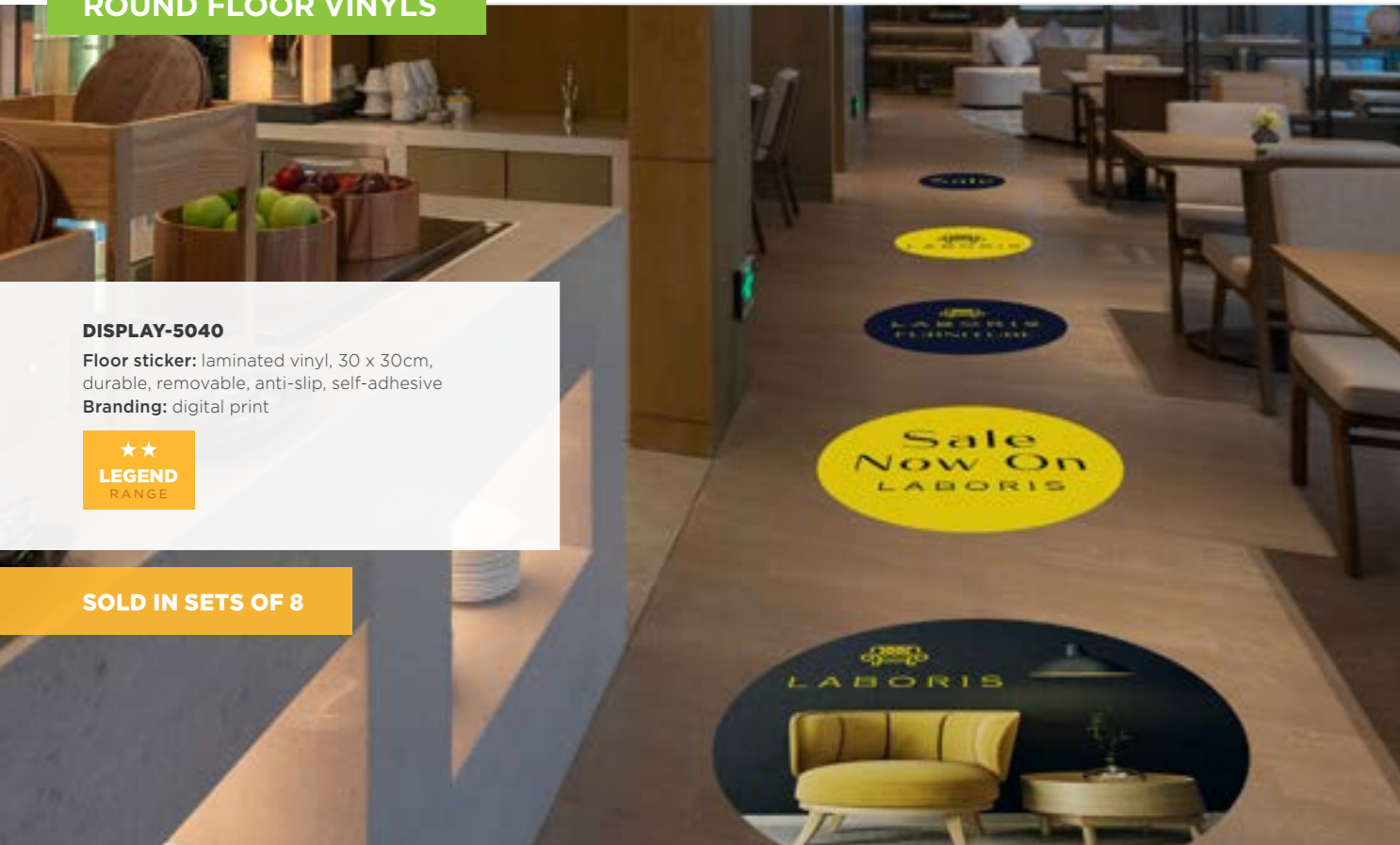

DISPLAY-5040
Floor sticker: laminated vinyl, 30 x 30cm, durable, removable, anti-slip, self-adhesive
Branding: digital print

★★
LEGEND
 RANGE

SOLD IN SETS OF 8

FLOOR STRIP VINYL

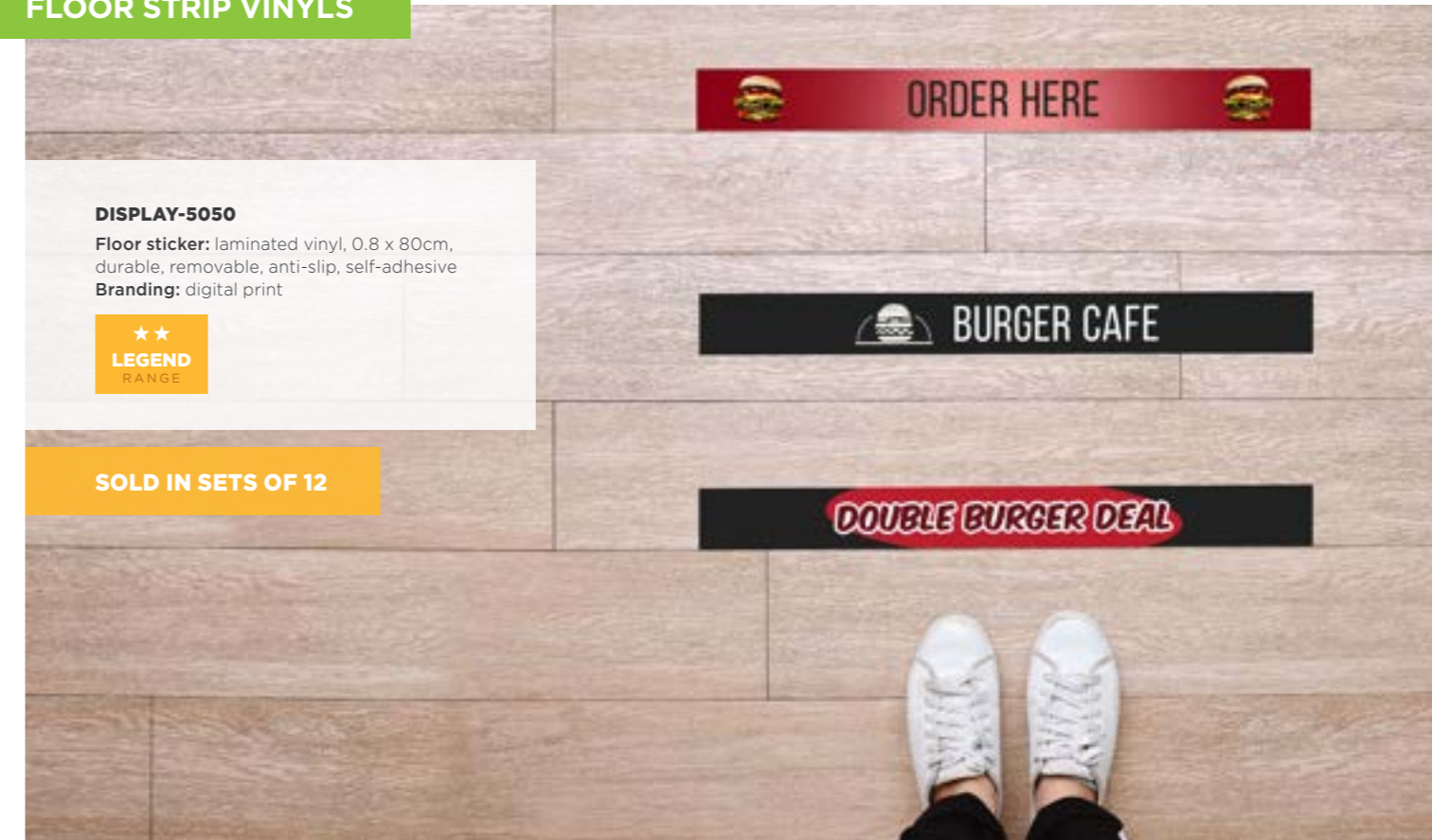

DISPLAY-5050
Floor sticker: laminated vinyl, 0.8 x 80cm, durable, removable, anti-slip, self-adhesive
Branding: digital print

★★
LEGEND
 RANGE

SOLD IN SETS OF 12



BANNERS

X-BANNERS

Sporting a unique and funky design, our attention-grabbing X-Banners are the most cost-effective mobile display solution for any brand. Their compact and lightweight design makes them extremely easy-to-assemble and dismantle.

The skins are available in Layflat Display PVC or Polyester Gazebo Display Fabric, which easily attach to the frame and store very well - making this range ideal for interchangeable artwork.

PULL UP BANNERS

Advertising your brand, products or services has never been easier! This range is compact, lightweight and durable, allowing setup within minutes. When all is said and done, the artwork simply retracts into the protective base and fits into a convenient carry bag.

Our Pull Up Banners are available in the following ranges:

★
CHAMPION
RANGE

An entry level option, offering great value without compromising on quality.

★★★
LEGEND
RANGE

Our middle of the range offering, with a slim design and chromed end caps for an upmarket and refined finish.

★★★★★
OVATION
RANGE

Defined by premium quality construction and durability, at an extremely competitive price point.

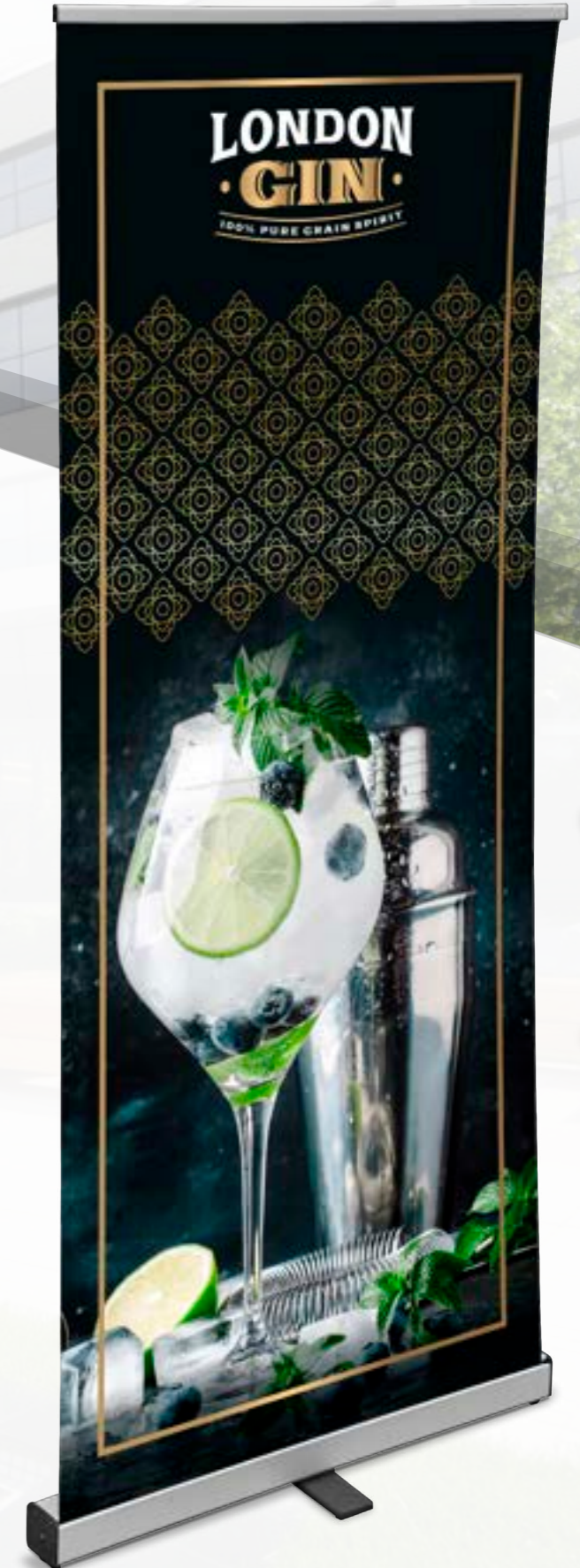

X-BANNERS

SPECIFICATIONS

- **Weight:** 2kg
- **1 x frame:** steel & fibre glass
- **Frame assembled size:** 0.60 x 1.6 x 0.80m
- **Bag:** Nylon
- **Bag size:** 112 x 15cm

	DISPLAY-6000	DISPLAY-6010
Skin included	1 x banner skin	1 x banner skin
Material	Layflat PVC	Gazebo display fabric
Visual size	0.60 x 1.6m	0.60 x 1.6m
Features	Roll-up neatly into carry bag	Roll-up neatly into carry bag. Crease resistant fabric
Branding	Single-sided digital print	Single-sided sublimation
Range		
Refresh the banner for multiple campaigns by buying a new skin		
Reskin Code	SKIN-6000	SKIN-6010

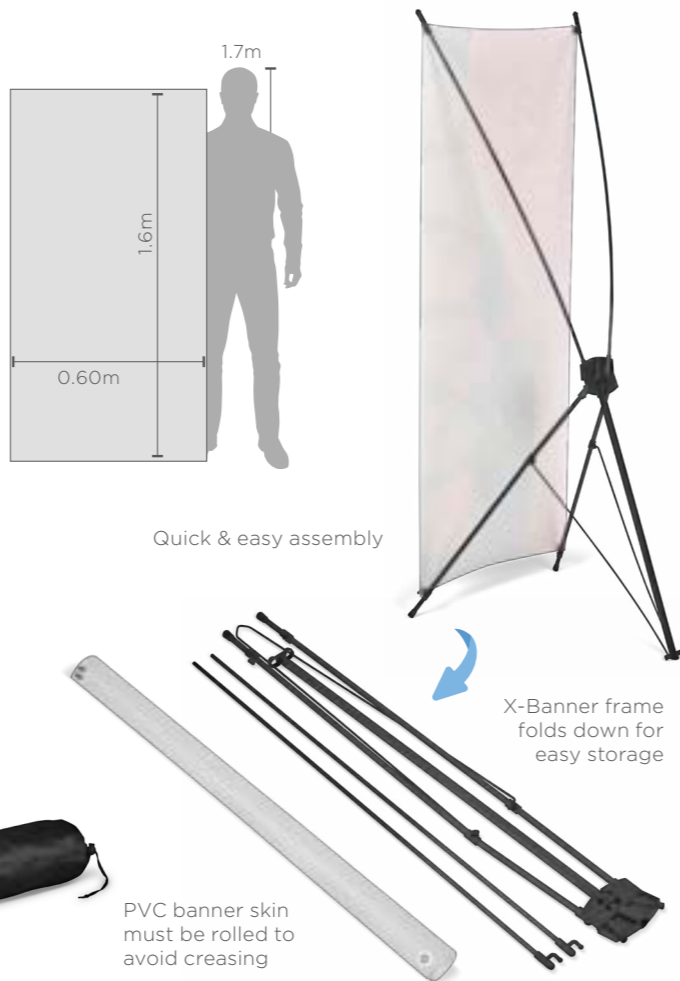

Carry bag included

X-BANNERS

SPECIFICATIONS

- **Weight:** 2.25kg
- **1 x frame:** steel & fibre glass
- **Frame assembled size:** 0.80 x 1.8 x 0.87m
- **Bag:** Nylon
- **Bag size:** 123 x 17cm

	DISPLAY-6005	DISPLAY-6015
Skin included	1 x banner skin	1 x banner skin
Material	Layflat PVC	Gazebo display fabric
Visual size	0.80 x 1.8m	0.80 x 1.8m
Features	Roll-up neatly into carry bag	Roll-up neatly into carry bag.
Branding	Single-sided digital print	Single-sided sublimation
Range		
Refresh the banner for multiple campaigns by buying a new skin		
Reskin Code	SKIN-6005	SKIN-6015



Carry bag included



PULL UP BANNERS

SPECIFICATIONS

- **Weight:** 2.9kg
- **1 x frame:** aluminium
- **Frame assembled size:** 0.85 x 2 x 0.1m
- **Bag:** polyester oxford
- **Bag size:** 90 x 8 x 8cm

	DISPLAY-4000	DISPLAY-4005
Skin included	1 x banner skin	1 x banner skin
Material	Layflat PVC	Gazebo display fabric
Visual size	0.85 x 2m	0.85 x 2m
Branding	Single-sided digital print	Single-sided sublimation
Range		
Refresh the banner for multiple campaigns by buying a new skin		
Reskin Code	SKIN-4000	SKIN-4005

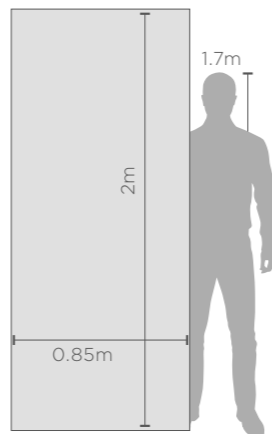

Foot on base of banner for extra stability



Frame folds up easily to fit into carry bag



DOUBLE-SIDED PULL UP BANNERS

SPECIFICATIONS

- **Weight:** 5.8kg
- **2 x frames:** aluminium
- **Frame assembled size:** 0.85 x 2 x 0.2m
- 2 interlocking mechanisms, positioned back to back
- **2 x bags:** polyester oxford
- **Bag size:** 90 x 8 x 8cm
- **1 x adapter kit:** PP

	DISPLAY-4030	DISPLAY-4035
Skin included	2 x banner skins	2 x banner skins
Material	Layflat PVC	Gazebo display fabric
Visual size	0.85 x 2m	0.85 x 2m
Branding	2 x single-sided digital prints. One print attached to each mechanism, making branding visible from both sides.	2 x single-sided sublimation prints. One print attached to each mechanism, making branding visible from both sides.
Range		
Refresh the banner for multiple campaigns by buying a new skin		
Reskin Code	2 x SKIN-4000	2 x SKIN-4005

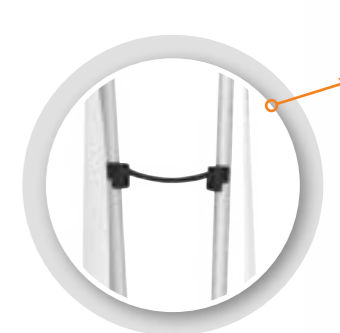
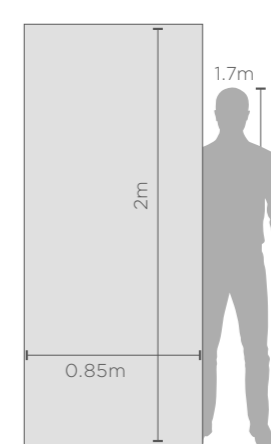

Pole brace adapter for stability



Frame folds up easily to fit into carry bag

1 x interlocking kit included

Convert 2 Champion Pull Up Banners into a double-sided display unit, by adding the ADAPT-4000 interlocking kit.



PULL UP BANNERS

SPECIFICATIONS

- **Weight:** 4.5kg
- **1 x frame:** aluminium
- **Frame assembled size:** 0.85 x 2 x 0.1m
- **Bag:** polyester oxford
- **Bag size:** 90 x 12 x 13cm

	DISPLAY-4010	DISPLAY-4015
Skin included	1 x banner skin	1 x banner skin
Material	Layflat PVC	Gazebo display fabric
Visual size	0.85 x 2m	0.85 x 2m
Branding	Single-sided digital print	Single-sided sublimation
Range	★★ LEGEND RANGE	★★ LEGEND RANGE
Refresh the banner for multiple campaigns by buying a new skin		
Reskin Code	SKIN-4000	SKIN-4005



PULL UP BANNERS

SPECIFICATIONS

- **Weight:** 5kg
- **1 x frame:** aluminium
- **Frame assembled size:** 0.85 x 2 x 0.2m
- **Bag:** polyester oxford
- **Bag size:** 92 x 10 x 21cm

	DISPLAY-4020	DISPLAY-4025
Skin included	1 x banner skin	1 x banner skin
Material	Layflat PVC	Gazebo display fabric
Visual size	0.85 x 2m	0.85 x 2m
Branding	Single-sided digital print	Single-sided sublimation
Range	★★★ OVATION RANGE	★★★ OVATION RANGE
Refresh the banner for multiple campaigns by buying a new skin		
Reskin Code	SKIN-4000	SKIN-4005



BANNER WALLS

Bannerwalls provide a substantial amount of real estate to display your brand - this display solution was designed to create an impression and draw attention!

The scissor frame is made from sturdy aluminium extrusions and fitted with recycled, plastic interlocking connectors, making these displays lightweight and easy-to-assemble and collapse. The crease-resistant skins easily attach to the frame with Velcro and can be collapsed on the frame for convenient storage.

The skins are made from Polyester Display Fabric, giving this display a soft, upmarket look and feel - Ideal for studios, photoshoots, interview backgrounds, entrances, brand launches, exhibitions, trade shows and events.





STRAIGHT BANNERWALLS

SPECIFICATIONS

- **Weight:** 6.9kg
- **1 x frame:** aluminium
- **Frame assembled size:** 1.52 x 2.25 x 0.3m
- **Bag:** polyester oxford
- **Bag size:** 85 x 29 x 24cm

DISPLAY-3050	
Skin included	1 x bannerwall skin
Material	Polyester display fabric
Visual size	1.52 x 2.25m
Features	Durable fabric
Branding	Single-sided sublimation
Range	★★ LEGEND RANGE
Refresh the banner for multiple campaigns by buying a new skin	
Reskin Code	SKIN-3050

Landscape or portrait orientation

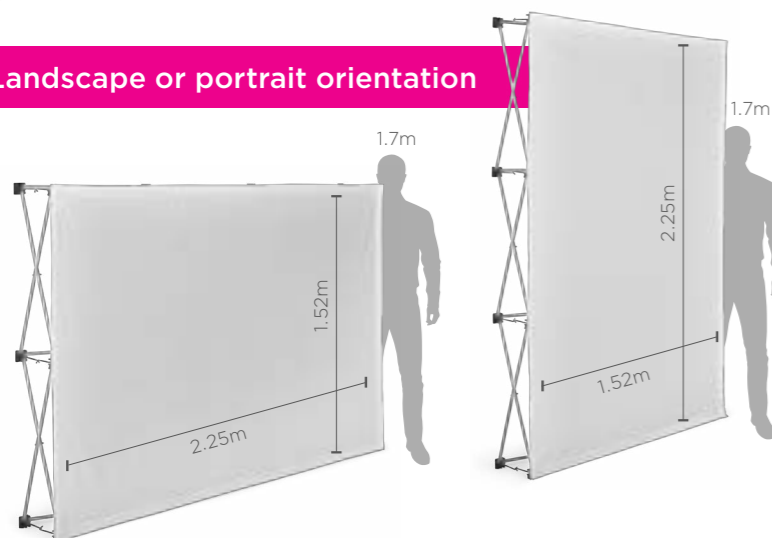

Collapsible scissor frame is made from sturdy aluminium extrusions and fitted with recycled, plastic interlocking connectors



Carry bag included



Collapsible bannerwall fits easily into carry bag



STRAIGHT BANNERWALLS



	1 DISPLAY-3055	2 DISPLAY-3060	3 DISPLAY-3065	4 DISPLAY-3070
Weight	9kg	11.2kg	13.9kg	15.6kg
Hardware	1 x frame: aluminium	1 x frame: aluminium	1 x frame: aluminium	1 x frame: aluminium
Frame assembled size	2.25 x 2.25 x 0.3m	3 x 2.25 x 0.3m	3.7 x 2.25 x 0.3m	4.45 x 2.25 x 0.3m
Bag material	Polyester oxford	Polyester oxford	Polyester oxford	Polyester oxford
Bag size	85 x 29 x 24cm	85 x 29 x 27cm	85 x 29 x 50cm	85 x 29 x 50cm
Skin included	1 x bannerwall skin	1 x bannerwall skin	1 x bannerwall skin	1 x bannerwall skin
Material	Polyester display fabric	Polyester display fabric	Polyester display fabric	Polyester display fabric
Visual size	2.25 x 2.25m	3 x 2.25m	3.7 x 2.25m	4.45 x 2.25m
Features	Durable fabric	Durable fabric	Durable fabric	Durable fabric
Branding	Single-sided sublimation	Single-sided sublimation	Single-sided sublimation	Single-sided sublimation
Range	★★ LEGEND RANGE	★★ LEGEND RANGE	★★ LEGEND RANGE	★★ LEGEND RANGE
Refresh the banner for multiple campaigns by buying a new skin				
Reskin Code	SKIN-3055	SKIN-3060	SKIN-3065	SKIN-3070

Collapsible scissor frame

Recycled, plastic interlocking connectors

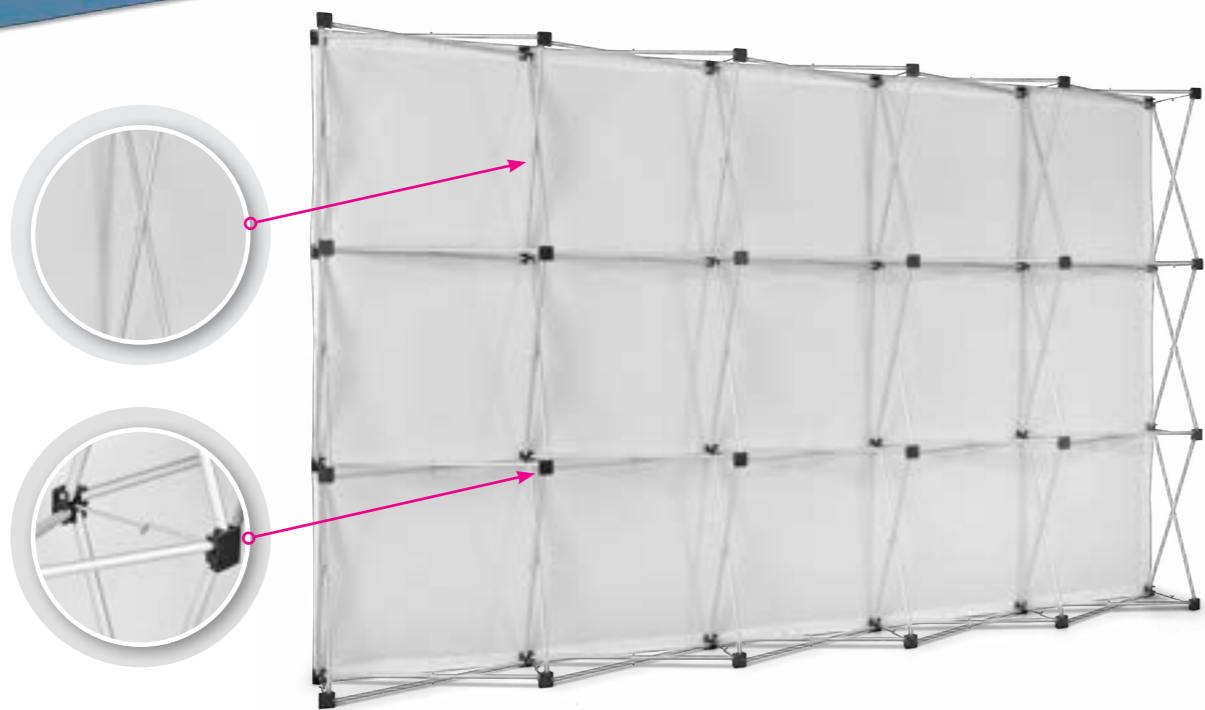

Carry bag included

Collapsible bannerwall fits easily into carry bag

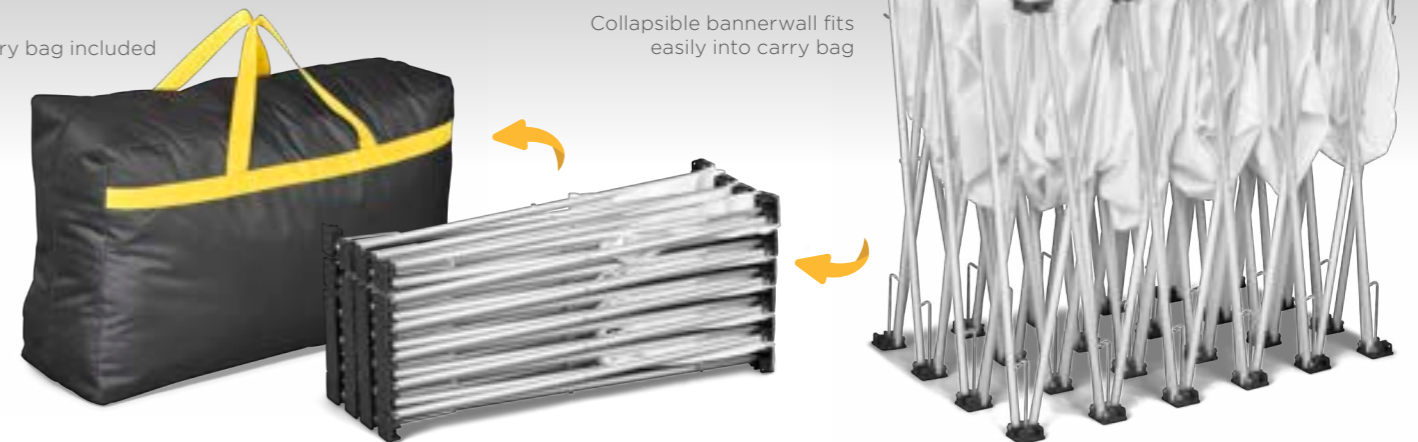



DOUBLE-SIDED STRAIGHT BANNERWALLS

SPECIFICATIONS

- **Weight:** 6.9kg
- **1 x frame:** aluminium
- **Frame assembled size:** 1.52 x 2.25 x 0.3m
- Double-sided
- **Bag:** polyester oxford
- **Bag size:** 85 x 29 x 24cm

Carry bag included



Second bannerwall skin



Collapsible bannerwall fits easily into carry bag

Landscape or portrait orientation

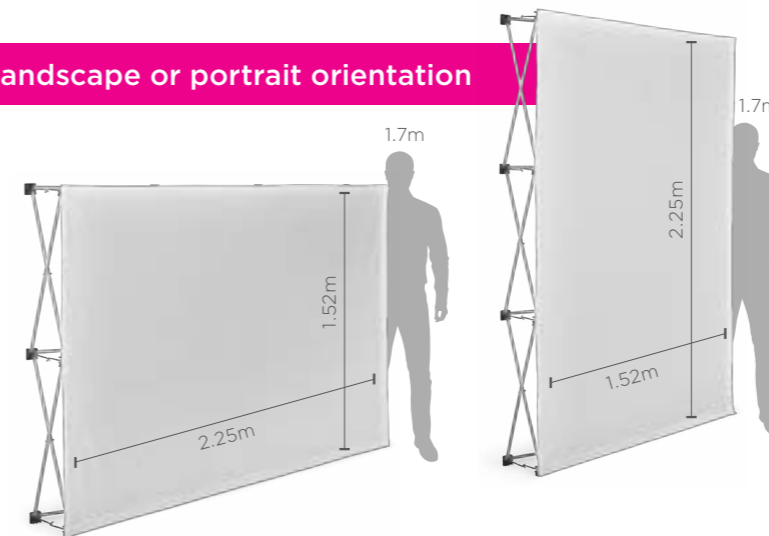

	DISPLAY-3075
Skin included	2 x bannerwall skins
Material	Polyester display fabric
Visual size	1.52 x 2.25m
Features	Durable fabric
Branding	2 x single-sided sublimation prints. One print attached to each side of the frame, making branding visible from both sides.
Range	<div style="text-align: center;"> ★ ★ LEGEND RANGE </div>
Refresh the banner for multiple campaigns by buying a new skin	
Reskin Code	2 x SKIN-3050



Skin easily attaches to frame with Velcro



Velcro is fitted around all edges of the frame allowing prints to be attached to both sides

DOUBLE-SIDED STRAIGHT BANNERWALLS



	1 DISPLAY-3080	2 DISPLAY-3085	3 DISPLAY-3090	4 DISPLAY-3095
Weight	9kg	11.2kg	13.9kg	15.6kg
Hardware	1 x frame: aluminium	1 x frame: aluminium	1 x frame: aluminium	1 x frame: aluminium
Frame assembled size	2.25 x 2.25 x 0.3m	3 x 2.25 x 0.3m	3.7 x 2.25 x 0.3m	4.45 x 2.25 x 0.3m
Bag material	Polyester oxford	Polyester oxford	Polyester oxford	Polyester oxford
Bag size	85 x 29 x 24cm	85 x 29 x 27cm	85 x 29 x 50cm	85 x 29 x 50cm
Skin included	2 x bannerwall skins	2 x bannerwall skins	2 x bannerwall skins	2 x bannerwall skins
Material	Polyester display fabric	Polyester display fabric	Polyester display fabric	Polyester display fabric
Visual size	2.25 x 2.25m	3 x 2.25m	3.7 x 2.25m	4.45 x 2.25m
Features	Durable fabric	Durable fabric	Durable fabric	Durable fabric
Branding	2 x single-sided sublimation prints. One print attached to each side of the frame, making branding visible from both sides.	2 x single-sided sublimation prints. One print attached to each side of the frame, making branding visible from both sides.	2 x single-sided sublimation prints. One print attached to each side of the frame, making branding visible from both sides.	2 x single-sided sublimation prints. One print attached to each side of the frame, making branding visible from both sides.
Range	★★ LEGEND RANGE	★★ LEGEND RANGE	★★ LEGEND RANGE	★★ LEGEND RANGE
Refresh the banner for multiple campaigns by buying a new skin				
Reskin Code	2 x SKIN-3055	2 x SKIN-3060	2 x SKIN-3065	2 x SKIN-3070





Collapsible scissor frame

Recycled, plastic interlocking connectors

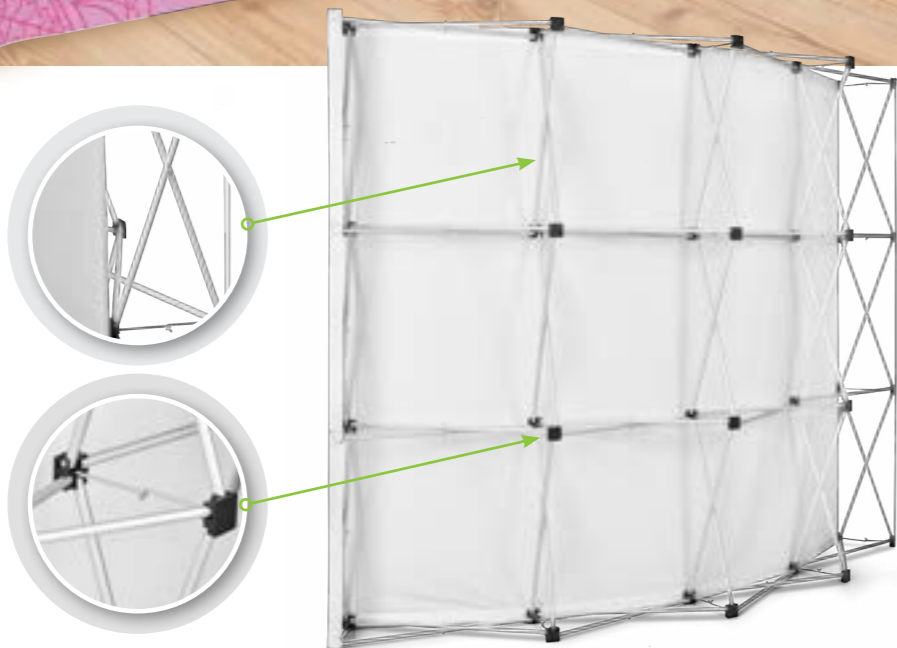

CURVED BANNERWALLS



	1 DISPLAY-3000	2 DISPLAY-3005	3 DISPLAY-3010	4 DISPLAY-3015	5 DISPLAY-3020
Weight	8kg	9.2kg	11.3kg	14.2kg	16.4kg
Hardware	1 x frame: aluminium	1 x frame: aluminium	1 x frame: aluminium	1 x frame: aluminium	1 x frame: aluminium
Frame assembled size	1.45 x 2.25 x 0.3m	2.15 x 2.25 x 0.3m	2.85 x 2.25 x 0.3m	3.5 x 2.25 x 0.3m	4.2 x 2.25 x 0.3m
Bag material	Polyester oxford	Polyester oxford	Polyester oxford	Polyester oxford	Polyester oxford
Bag size	85 x 24 x 27cm	85 x 30 x 27cm	85 x 27 x 33cm	85 x 30 x 38cm	82 x 25 x 50cm
Skin included	1 x bannerwall skin	1 x bannerwall skin	1 x bannerwall skin	1 x bannerwall skin	1 x bannerwall skin
Material	Polyester display fabric	Polyester display fabric	Polyester display fabric	Polyester display fabric	Polyester display fabric
Visual size	1.45 x 2.25m	2.15 x 2.25m	2.85 x 2.25m	3.5 x 2.25m	4.2 x 2.25m
Features	Durable fabric	Durable fabric	Durable fabric	Durable fabric	Durable fabric
Branding	Single-sided sublimation	Single-sided sublimation	Single-sided sublimation	Single-sided sublimation	Single-sided sublimation
Range	★★ LEGEND RANGE	★★ LEGEND RANGE	★★ LEGEND RANGE	★★ LEGEND RANGE	★★ LEGEND RANGE
Refresh the banner for multiple campaigns by buying a new skin					
Reskin Code	SKIN-3000	SKIN-3005	SKIN-3010	SKIN-3015	SKIN-3020

Carry bag included



Collapsible bannerwall fits easily into carry bag



CURVED BANNERWALLS WITH WINGS



	1 DISPLAY-3025	2 DISPLAY-3030	3 DISPLAY-3035	4 DISPLAY-3040	5 DISPLAY-3045
Weight	8kg	9.2kg	11.3kg	14.2kg	16.4kg
Hardware	1 x frame: aluminium	1 x frame: aluminium	1 x frame: aluminium	1 x frame: aluminium	1 x frame: aluminium
Frame assembled size	1.45 x 2.25 x 0.3m	2.15 x 2.25 x 0.3m	2.85 x 2.25 x 0.3m	3.5 x 2.25 x 0.3m	4.2 x 2.25 x 0.3m
Bag material	Polyester oxford	Polyester oxford	Polyester oxford	Polyester oxford	Polyester oxford
Bag size	85 x 24 x 27cm	85 x 30 x 27cm	85 x 27 x 33cm	85 x 30 x 38cm	82 x 25 x 50cm
Wings material	2 x wings: PP	2 x wings: PP	2 x wings: PP	2 x wings: PP	2 x wings: PP
Wing features	Allows for wrap around visuals	Allows for wrap around visuals	Allows for wrap around visuals	Allows for wrap around visuals	Allows for wrap around visuals
Skin included	1 x bannerwall skin	1 x bannerwall skin	1 x bannerwall skin	1 x bannerwall skin	1 x bannerwall skin
Material	Polyester display fabric	Polyester display fabric	Polyester display fabric	Polyester display fabric	Polyester display fabric
Visual size	2.37 x 2.25m	3.04 x 2.25m	3.7 x 2.25m	4.38 x 2.25m	5.08 x 2.25m
Features	Durable fabric	Durable fabric	Durable fabric	Durable fabric	Durable fabric
Branding	Single-sided sublimation	Single-sided sublimation	Single-sided sublimation	Single-sided sublimation	Single-sided sublimation
Range	★★ LEGEND RANGE	★★ LEGEND RANGE	★★ LEGEND RANGE	★★ LEGEND RANGE	★★ LEGEND RANGE
Refresh the banner for multiple campaigns by buying a new skin					
Reskin Code	SKIN-3025	SKIN-3030	SKIN-3035	SKIN-3040	SKIN-3045

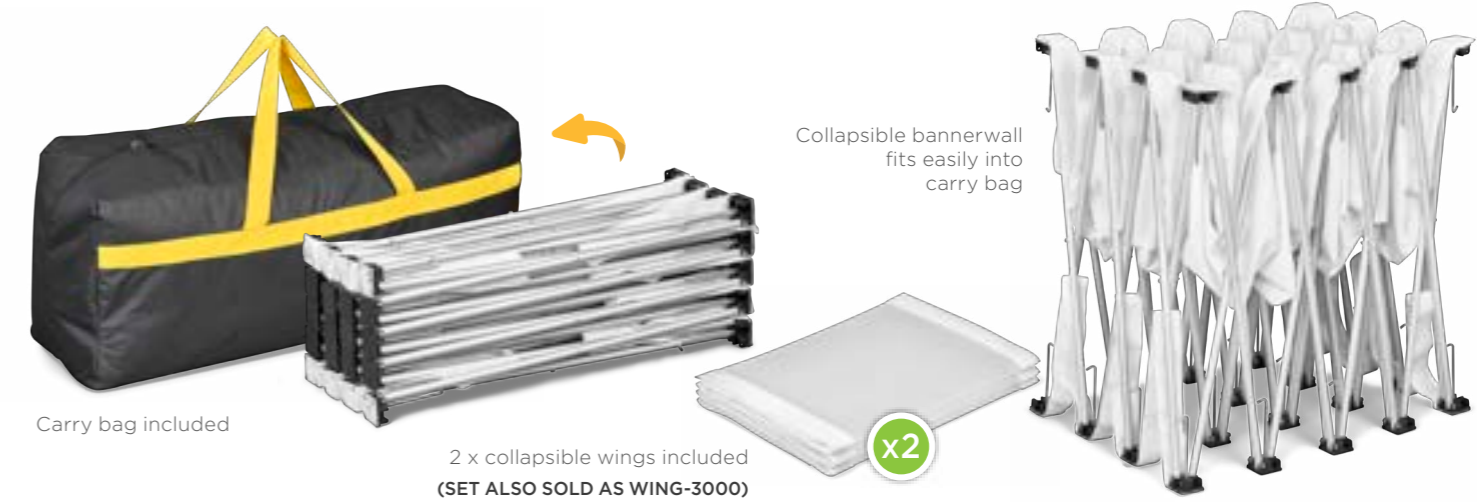

TABLE CLOTHS

Make the most of your space, maximise your brand exposure and enhance your overall appearance with our range of slip over, spandex, fabric and PVC Table Cloths.

PVC TABLE CLOTHS



DISPLAY-5020

Weight: 0.32kg

Material: PVC

Size: 2 x 1.25m

Features: durable, lightweight, wipe-down, knife-cut edge

Branding: single-sided digital print



SLIP OVER TABLE CLOTHS



DISPLAY-5035

Weight: 1.8kg

Material: polyester spandex

Size: tailored to fit a standard trestle table: 1.83 x 0.76 x 0.75m

Features: fitted table cloth, durable, lightweight, washable, hemmed

Branding: single-sided sublimation

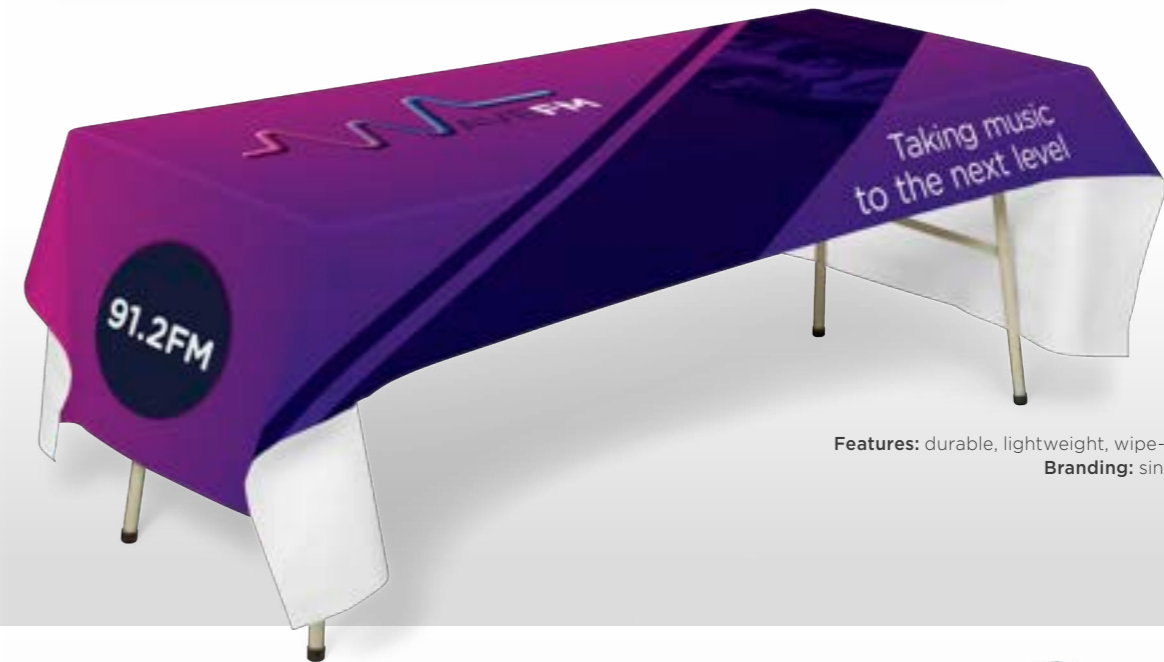

DISPLAY-5025

Weight: 0.47kg

Material: PVC

Size: 3 x 1.25m

Features: durable, lightweight, wipe-down, knife-cut edge

Branding: single-sided digital print



DISPLAY-5055

Weight: 1.8kg

Material: polyester display fabric

Size: tailored to fit a standard trestle table: 1.83 x 0.76 x 0.75m

Features: fitted table cloth, durable, washable, hemmed

Branding: single-sided sublimation



DISPLAY-5030

Weight: 0.55kg

Material: PVC

Size: 3.5 x 1.25m

Features: durable, lightweight, wipe-down, knife-cut edge

Branding: single-sided digital print



FABRIC TABLE CLOTHS



DISPLAY-5000

Weight: 0.51kg
Material: polyester display fabric
Size: 2 x 1m
Features: durable, lightweight, washable, hemmed
Branding: single-sided sublimation

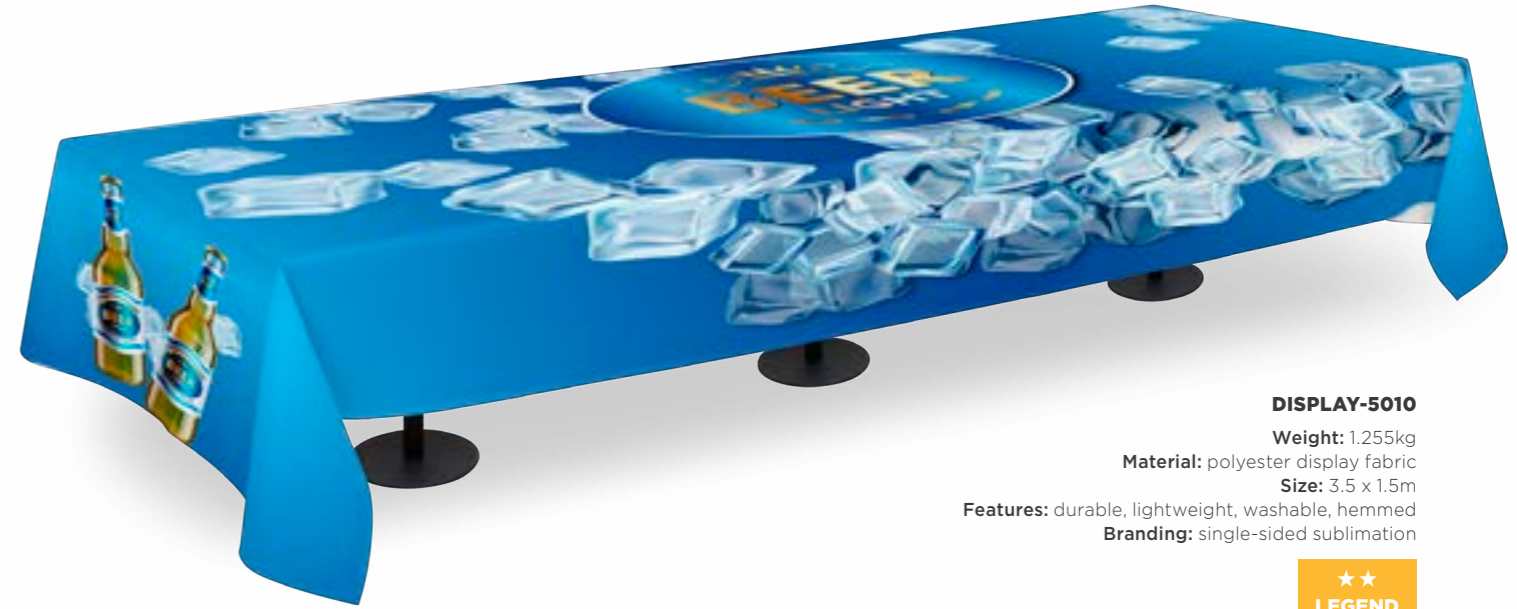

DISPLAY-5010

Weight: 1.255kg
Material: polyester display fabric
Size: 3.5 x 1.5m
Features: durable, lightweight, washable, hemmed
Branding: single-sided sublimation



DISPLAY-5005

Weight: 0.90kg
Material: polyester display fabric
Size: 2.5 x 1.5m
Features: durable, lightweight, washable, hemmed
Branding: single-sided sublimation



DISPLAY-5015

Weight: 1.84kg
Material: polyester display fabric
Size: 3.35 x 2.25m
Features: durable, lightweight, washable, hemmed
Branding: single-sided sublimation





FLAGS

DESK FLAGS

Ideal for client gifts, Desk Flags offer a unique platform to show your support, back a team, unite for a cause or celebrate your heritage.

HAND FLAGS

Let your brand make waves!

Ideal for sporting events, marches and commemorating special events or holidays – this range is bound to be a crowd-pleasing favourite.



FLAG FOUNTAINS

Available in four and five pole configurations, these flags attach to a single base allowing you to promote multiple messages simultaneously.

The lightweight, anti-fray fabric allows for a reversed visual – ideal for car dealerships, forecourts, brand activations and events.



DESK FLAGS

DISPLAY-1000

Weight: 0.15kg
Pole: PP, 30.8cm
Base: PP, 1.7 x 9.7cm dia
Material: polyester warp knit, anti-fray
Visual size: 15 x 10cm
Branding: single-sided sublimation

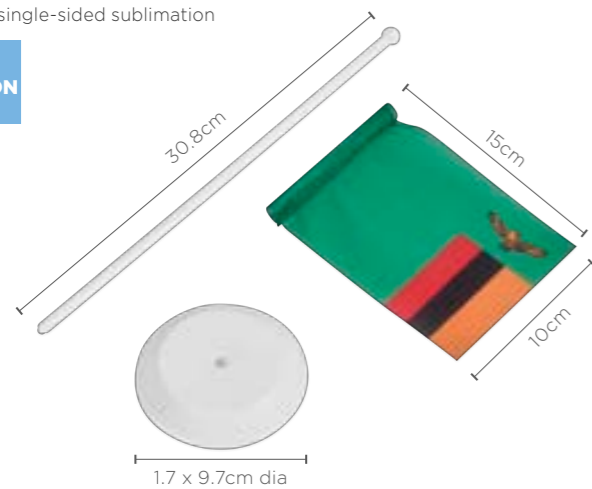

DISPLAY-1005

Weight: 0.16kg
Pole: PP, 30.8cm
Base: PP, 1.7 x 9.7cm dia
Material: polyester warp knit, anti-fray
Visual size: 22 x 15cm
Branding: single-sided sublimation

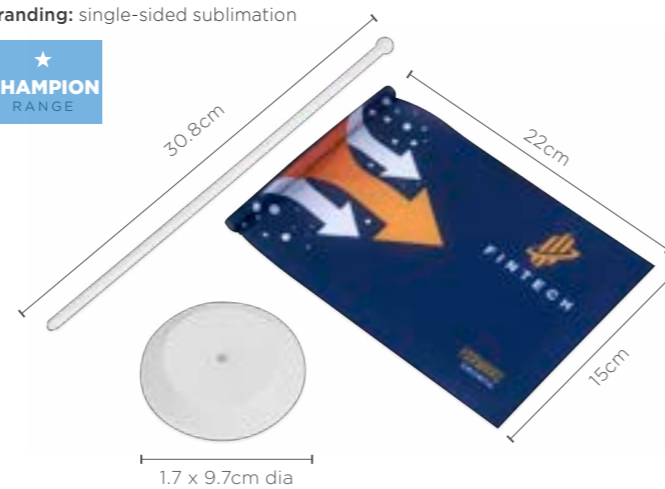

HAND FLAGS

1 DISPLAY-1010

Weight: 0.20kg
Dowel: wood, 45 x 0.6cm dia
Material: polyester warp knit, anti-fray
Visual size: 20 x 30cm
Branding: single-sided sublimation



2 DISPLAY-1015

Weight: 0.22kg
Dowel: wood, 90 x 1cm dia
Material: polyester warp knit, anti-fray
Visual size: 30 x 45cm
Branding: single-sided sublimation

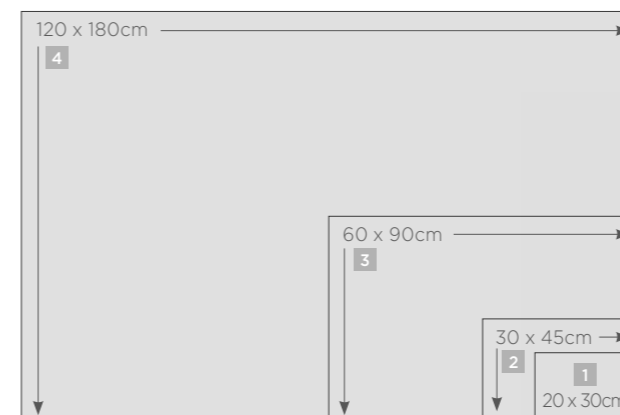

3 DISPLAY-1020

Weight: 0.55kg
Dowel: wood, 140 x 1.6cm dia
Material: polyester warp knit, anti-fray
Visual size: 60 x 90cm
Branding: single-sided sublimation



4 DISPLAY-1040

Weight: 0.6kg
Dowel: wood, 180 x 1.6cm dia
Material: polyester warp knit, anti-fray
Visual size: 120 x 180cm
Branding: single-sided sublimation



FLAG FOUNTAINS



1 Flag fountain base

DISPLAY-1025
Weight: 14.35kg
Hardware: 4 x poles: aluminium & steel, 6m
Hardware bag: polyester oxford, 144 x 34cm
Base: steel, 1 x 1m
Base bag: Polyester oxford, 60 x 20 x 15cm
Material: 4 x flag skins, polyester warp knit, anti-fray
Visual size: 1 x 4m
Branding: single-sided sublimation

Refresh the flag fountain for multiple campaigns by buying a new skin
 Reskin code: FLAG-1030



2 Flag fountain base

DISPLAY-1030
Weight: 16.05kg
Hardware: 5 x poles: aluminium & steel, 6m
Hardware bag: polyester oxford, 144 x 34cm
Base: steel, 1 x 1m
Base bag: Polyester oxford, 60 x 20 x 15cm
Material: 5 x flag skins, polyester warp knit, anti-fray
Visual size: 1 x 4m
Branding: single-sided sublimation

Refresh the flag fountain for multiple campaigns by buying a new skin
 Reskin code: FLAG-1030

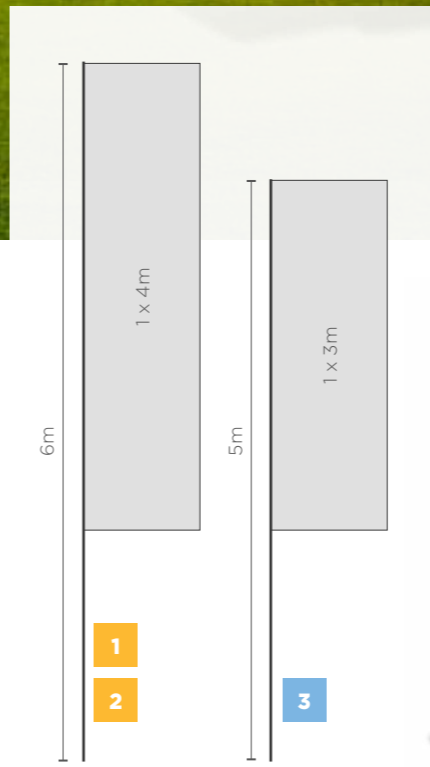

Flag fountain base

3 **DISPLAY-1035**
Weight: 8.1kg
Hardware: 4 x poles: aluminium & steel, 5m
Hardware bag: polyester oxford, 137 x 34cm
Base: steel, 0.79 x 0.79m
Base bag: Polyester oxford, 60 x 16 x 15cm
Material: 4 x flag skins, polyester warp knit, anti-fray
Visual size: 1 x 3m
Branding: single-sided sublimation

Refresh the flag fountain for multiple campaigns by buying a new skin
 Reskin code: FLAG-1025





POP-UP BANNER

This high-impact display solution literally pops up and assembles itself!

Our Pop-Up Banners are manufactured with a crease-resistant Polyester, which easily twists and folds into a convenient carry bag.

Ideal for golf days and sporting events - the double-sided design allows you to maximise your brand exposure.



POP-UP BANNER

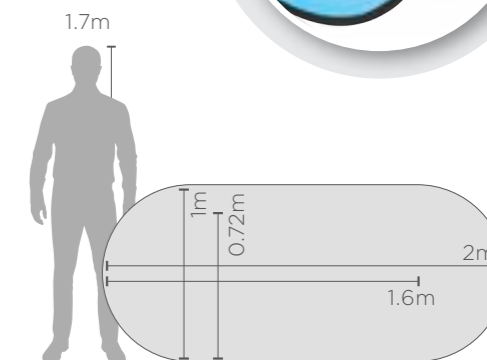
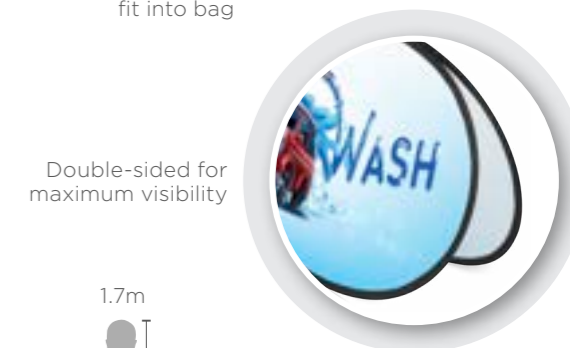

	DISPLAY-8020	VI-AM-210-D
Weight	3.1kg	2.9kg
Hardware	1 x frame: fibre rod	1 x frame: fibre rod
Frame assembled size	2 x 1 x 0.4m	1.6 x 0.72m
Bag material	Polyester oxford	Polyester oxford
Bag size	85cm dia	85cm dia
Skin included	2 x pop-up skins	2 x pop-up skins
Material	Polyester display fabric	Polyester display fabric
Visual size	1.98 x 0.9m	1.6 x 0.72m
Features	Crease resistant, lightweight, easy setup	Crease resistant, lightweight, easy setup
Accessories	4 x ground spikes: steel	4 x ground spikes: steel
Branding	2 x single-sided sublimation prints tailored to fit the frame, making branding visible from both sides.	2 x single-sided sublimation prints tailored to fit the frame, making branding visible from both sides.
Range	★★ LEGEND RANGE	★★ LEGEND RANGE
Refresh the banner for multiple campaigns by buying a new skin		
Reskin Code	2 x SKIN-8020	2 x PU-AM-4-D



SUBLIMATED A-FRAME BANNERS

Ideal for indoor or outdoor use, our A-Frames are manufactured with a sturdy aluminium frame, which is lightweight and easy-to-assemble. The skins easily attach to the frame with Velcro straps making this solution ideal for interchangeable artwork.

This display can be purchased with your choice of Blockout PVC Skins or Polyester Display Fabric Skins depending on your requirements.

BLOCKOUT PVC

A lightweight and resilient substrate with 100% opacity, which prevents light from filtering through the display - ensuring maximum visibility indoors and outdoors.

POLYESTER DISPLAY FABRIC

A lightweight, crease-resistant fabric that can be washed in cold water and easily stored - recommended for indoor use.



Fabric skins have white backing

Double-sided for maximum visibility

Blockout PVC skins have black backing



A-FRAME BANNERS

Carry bag included

	DISPLAY-8000	DISPLAY-8005	DISPLAY-8010	DISPLAY-8015
Weight	3.2kg	3.8kg	3.2kg	3.8kg
Hardware	1 x frame: aluminium	1 x frame: aluminium	1 x frame: aluminium	1 x frame: aluminium
Frame assembled size	2 x 1 x 1m	3 x 1 x 1m	2 x 1 x 1m	3 x 1 x 1m
Bag material	Polyester oxford	Polyester oxford	Polyester oxford	Polyester oxford
Bag size	129 x 23cm	129 x 23cm	129 x 23cm	129 x 23cm
Skin included	2 x A-frame skins	2 x A-frame skins	2 x A-frame skins	2 x A-frame skins
Material	PVC	PVC	Polyester display fabric	Polyester display fabric
Visual size	1.95 x 0.95m	2.95 x 0.95m	1.95 x 0.95m	2.95 x 0.95m
Features	UV stable	UV stable	Crease resistant	Crease resistant
Branding	2 x single-sided digital prints tailored to fit the frame, making branding visible from both sides.	2 x single-sided digital prints tailored to fit the frame, making branding visible from both sides.	2 x single-sided sublimation prints tailored to fit the frame, making branding visible from both sides.	2 x single-sided sublimation prints tailored to fit the frame, making branding visible from both sides.
Range				
Refresh the banner for multiple campaigns by buying a new skin				
Reskin Code	2 x SKIN-8000	2 x SKIN-8005	2 x SKIN-8010	2 x SKIN-8015



FADE RESISTANT A-FRAME BANNERS

Our Fade Resistant Displays are printed with state-of-the-art Latex Gen-4 inks, boasting the widest colour gamut on the market.

This allows us to print the widest range of colours within the colour spectrum and produce the most vibrant and vivid print results.

The inks have a low environmental impact, are UV stable and scratch resistant, providing great durability for long-term outdoor exposure.

Premium polyester fabric with a unique print-guard coating is used for all of our Fade Resistant A-Frame Banners



A-FRAME BANNERS

	VI-AM-148-D	VI-AM-146-D
Weight	3.2kg	3.8kg
Hardware	1 x frame: aluminium	1 x frame: aluminium
Frame assembled size	2 x 1 x 1m	3 x 1 x 1m
Bag material	Polyester oxford	Polyester oxford
Bag size	129 x 23cm	129 x 23cm
Skin included	2 x A-frame skins	2 x A-frame skins
Material	Polyester print-guard fabric, water resistant	Polyester print-guard fabric, water resistant
Visual size	1.95 x 0.95m	2.95 x 0.95m
Features	Fade resistant	Fade resistant
Branding	Latex Gen-4 printing	Latex Gen-4 printing
Range		
Refresh the banner for multiple campaigns by buying a new skin		
Reskin Code	AF-AM-7-D	AF-AM-8-D

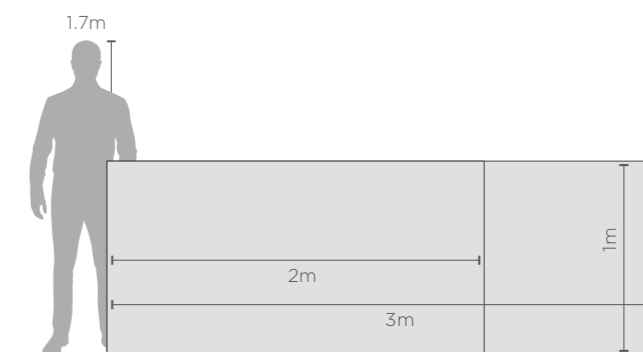

FLYING BANNERS

Available in a variety of shapes and sizes, this diverse range has been designed to withstand the elements while offering high-impact visibility for your brand.

Our entire range of Arcfin, Sharkfin and Telescopic Flying Banners include a ground spike and convenient carry bag. These displays are predominantly used outdoors, however can be converted into indoor displays with our range of optional extras.

SINGLE-SIDED FLYING BANNERS

Only sold in pairs - this option offers exceptional value at an extremely competitive price point.

DOUBLE-SIDED FLYING BANNERS

Two skins are tailored back-to-back with blockout material in between to offer a perfect double-sided visual.





ARCFIN FLYING BANNERS

	1 DISPLAY-7022	2 DISPLAY-7023	3 DISPLAY-7024
	Sold in sets of 2, info below is per unit		
Weight	1.5kg	1.7kg	3.6kg
Hardware	2 x poles: aluminium	2 x poles: aluminium	3 x poles: aluminium
Frame assembled size	2m	3m	4m
Accessories	2 x rods: fibre 1 x ground spike: steel	2 x rods: fibre 1 x ground spike: steel	2 x rods: fibre 1 x ground spike: steel
Bag material	Polyester oxford	Polyester oxford	Polyester oxford
Bag size	137 x 18cm	137 x 18cm	137 x 18cm
Skin included	1 x banner skin	1 x banner skin	1 x banner skin
Material	Polyester warp knit	Polyester warp knit	Polyester warp knit
Visual size	0.61 x 2.59m	0.68 x 3.83m	0.68 x 4.87m
Features	Anti-fray	Anti-fray	Anti-fray
Branding	Single-sided sublimation	Single-sided sublimation	Single-sided sublimation
Range	★★ LEGEND RANGE	★★ LEGEND RANGE	★★ LEGEND RANGE
Refresh the banner for multiple campaigns by buying a new skin (SOLD IN SETS OF 2)			
Reskin Code	SKIN-7022	SKIN-7023	SKIN-7024

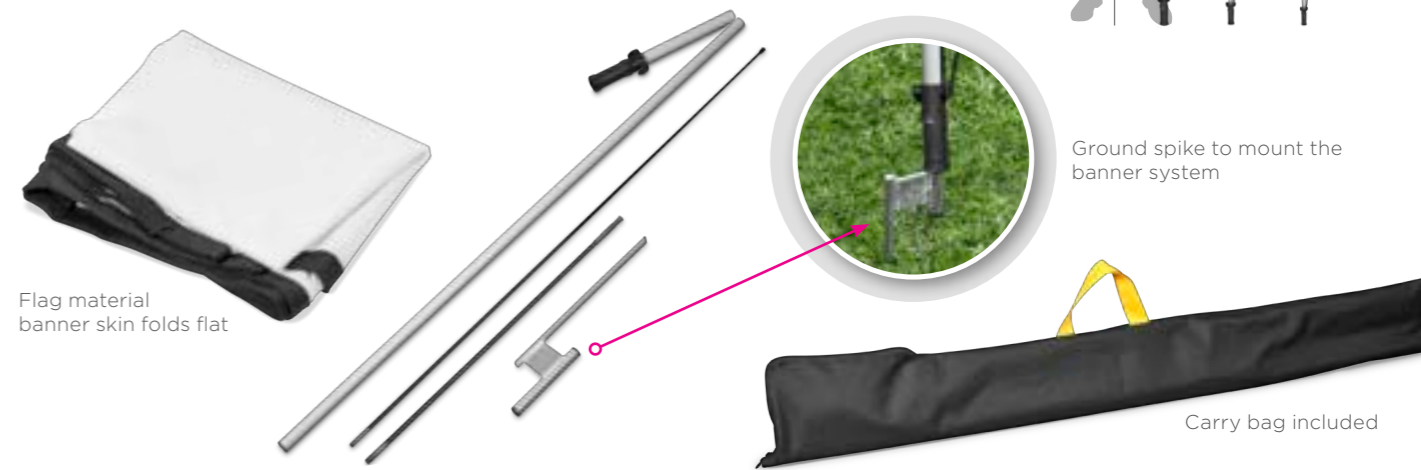
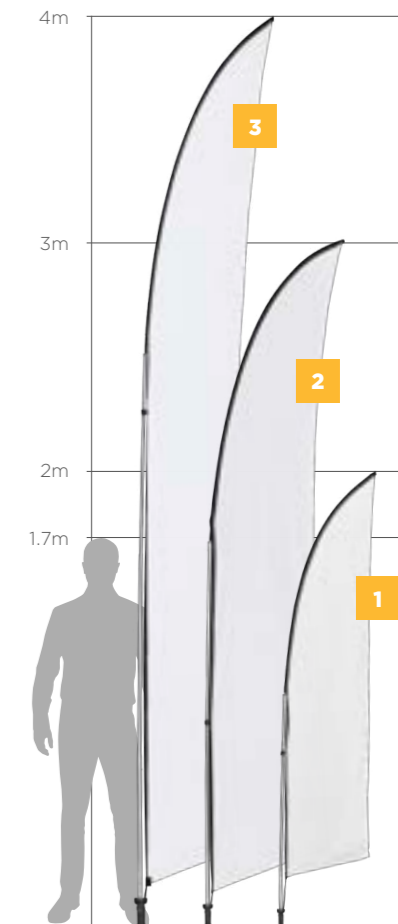

OPTIONAL EXTRAS FOR THE ARCFIN FLYING BANNERS



DISPLAY-7000
LEGEND FLYING BANNER GROUND SPIKE
ground spike: steel

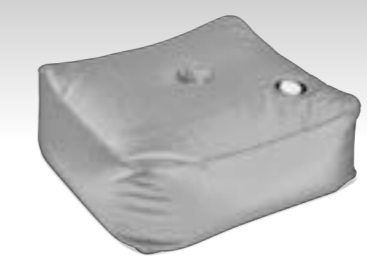

DISPLAY-7050
LEGEND FLYING BANNER 20L SQUARE WATER BASE
base: PP, refill with 20L water, collapsible

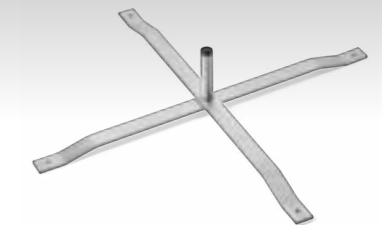

DISPLAY-7051
LEGEND FLYING BANNER SCISSOR BASE
base: steel, size: 60 x 60cm

DOUBLE-SIDED ARCFIN FLYING BANNERS

	1 DISPLAY-7032	2 DISPLAY-7033	3 DISPLAY-7034
Weight	2kg	2.2kg	3.2kg
Hardware	2 x poles: aluminium	2 x poles: aluminium	3 x poles: aluminium
Frame assembled size	2m	3m	4m
Accessories	2 x rods: fibre	2 x rods: fibre	2 x rods: fibre
	1 x ground spike: steel	1 x ground spike: steel	1 x ground spike: steel
Bag material	Polyester oxford	Polyester oxford	Polyester oxford
Bag size	137 x 18cm	137 x 18cm	137 x 18cm
Skin included	1 x banner skin	1 x banner skin	1 x banner skin
Material	Polyester warp knit	Polyester warp knit	Polyester warp knit
Visual size	0.61 x 2.59m	0.68 x 3.83m	0.68 x 4.87m
Features	Anti-fray	Anti-fray	Anti-fray
Branding	Double-sided sublimation	Double-sided sublimation	Double-sided sublimation
Range	★★ LEGEND RANGE	★★ LEGEND RANGE	★★ LEGEND RANGE
Refresh the banner for multiple campaigns by buying a new skin			
Reskin Code	SKIN-7032	SKIN-7033	SKIN-7034

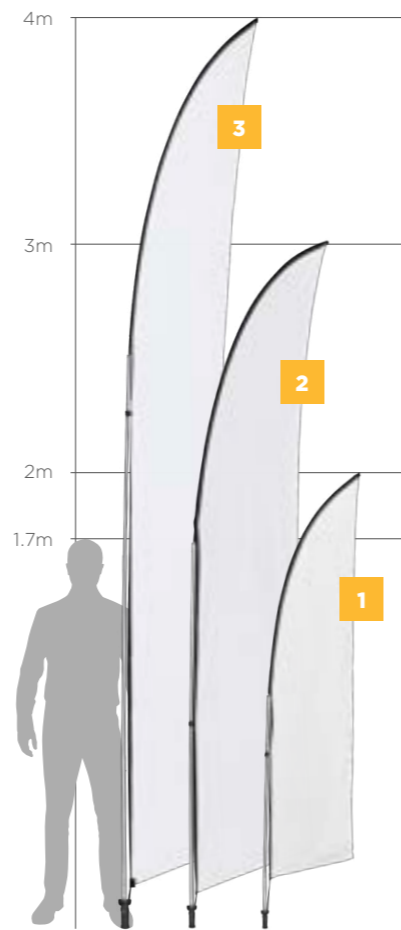

OPTIONAL EXTRAS FOR THE DOUBLE-SIDED ARCFIN FLYING BANNERS



DISPLAY-7000

LEGEND FLYING BANNER GROUND SPIKE
ground spike: steel

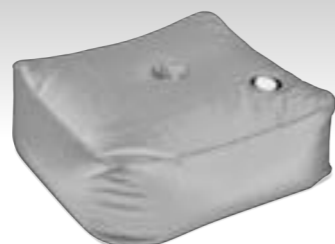

DISPLAY-7050

LEGEND FLYING BANNER 20L SQUARE WATER BASE
base: PP, refill with 20L water, collapsible

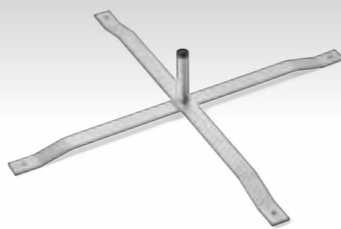

DISPLAY-7051

LEGEND FLYING BANNER SCISSOR BASE
base: steel, size: 60 x 60cm

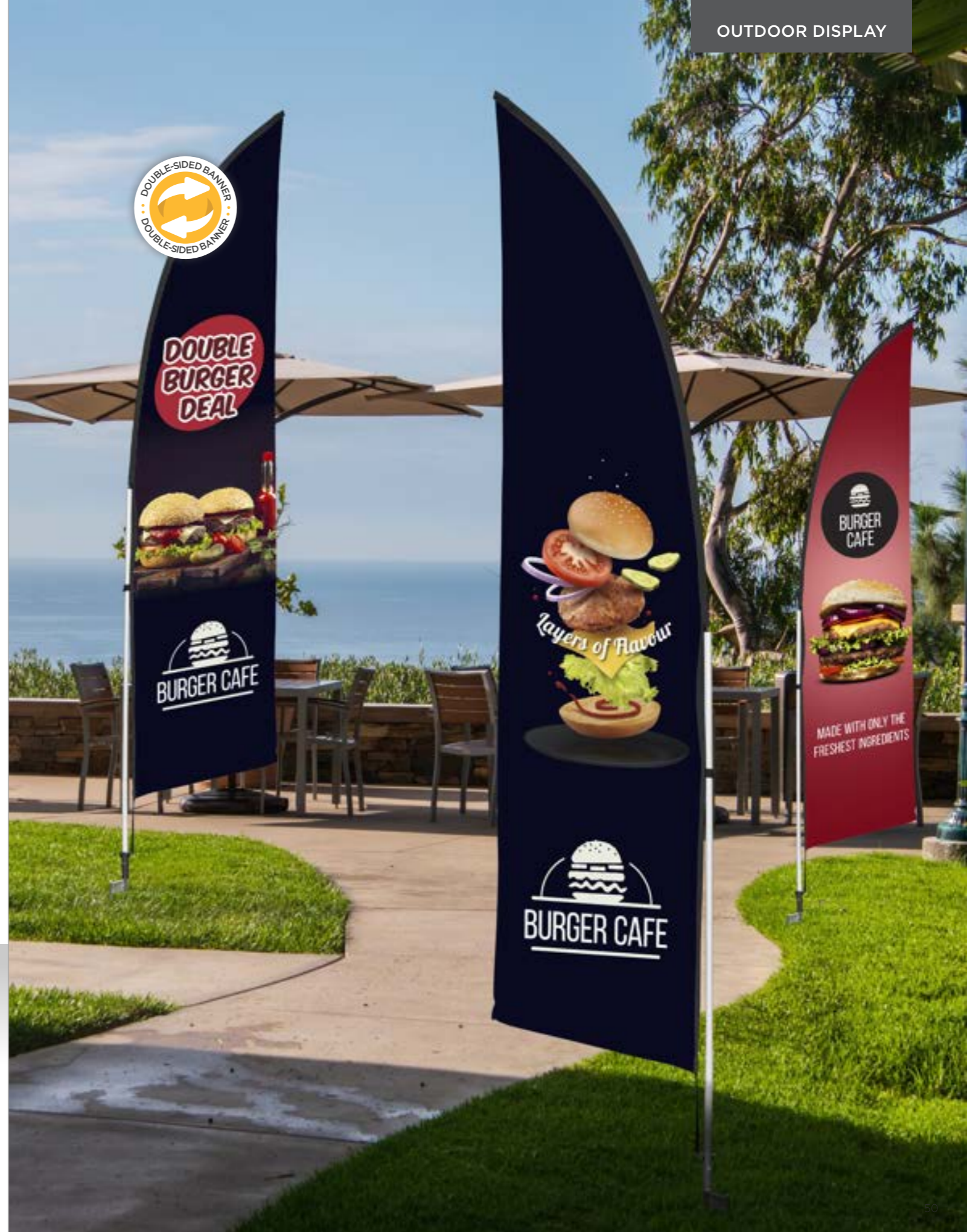



SHARKFIN FLYING BANNERS

	1 DISPLAY-7002	2 DISPLAY-7003	3 DISPLAY-7004
	Sold in sets of 2, info below is per unit		
Weight	1.4kg	1.7kg	1.9kg
Hardware	2 x poles: aluminium	2 x poles: aluminium	3 x poles: aluminium
Frame assembled size	2m	3m	4m
Accessories	2 x rods: fibre 1 x ground spike: steel	2 x rods: fibre 1 x ground spike: steel	2 x rods: fibre 1 x ground spike: steel
Bag material	Polyester oxford	Polyester oxford	Polyester oxford
Bag size	137 x 18cm	137 x 18cm	137 x 18cm
Skin included	1 x banner skin	1 x banner skin	1 x banner skin
Material	Polyester warp knit	Polyester warp knit	Polyester warp knit
Visual size	0.98 x 2.24m	1.38 x 3.3m	1.14 x 4.4m
Features	Anti-fray	Anti-fray	Anti-fray
Branding	Single-sided sublimation	Single-sided sublimation	Single-sided sublimation
Range	★★ LEGEND RANGE	★★ LEGEND RANGE	★★ LEGEND RANGE
Refresh the banner for multiple campaigns by buying a new skin (SOLD IN SETS OF 2)			
Reskin Code	SKIN-7002	SKIN-7003	SKIN-7004

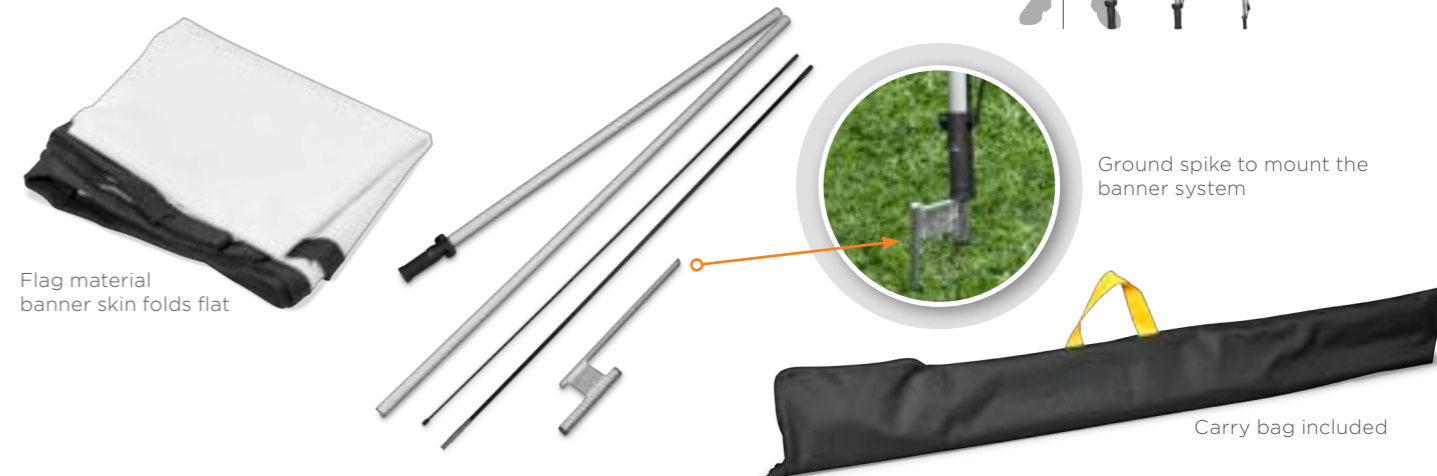
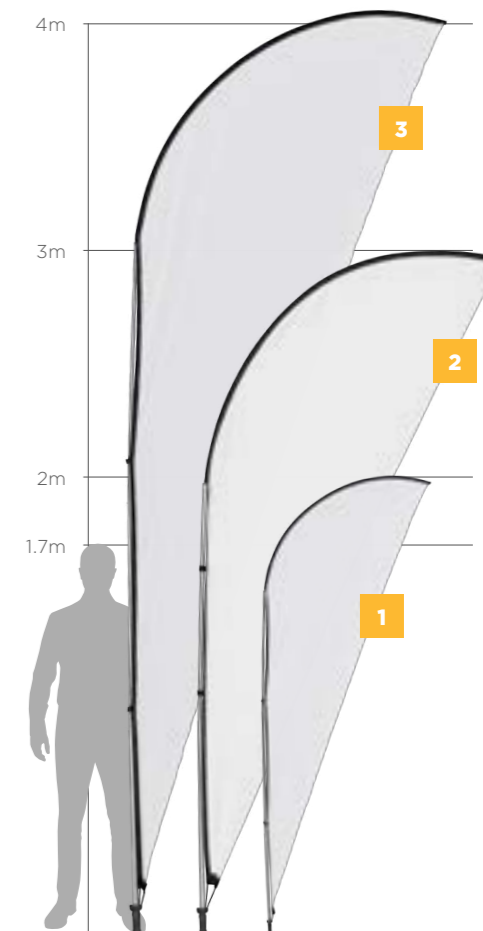

OPTIONAL EXTRAS FOR THE SHARKFIN FLYING BANNERS



DISPLAY-7000
LEGEND FLYING BANNER GROUND SPIKE
ground spike: steel

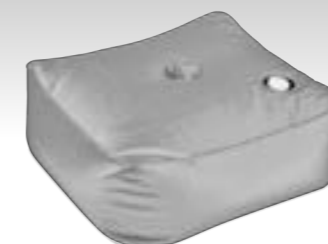

DISPLAY-7050
LEGEND FLYING BANNER 20L SQUARE WATER BASE
base: PP, refill with 20L water, collapsible

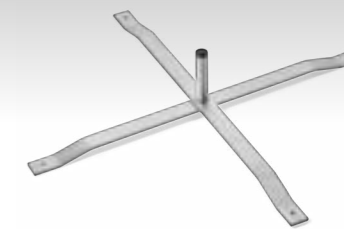

DISPLAY-7051
LEGEND FLYING BANNER SCISSOR BASE
base: steel, size: 60 x 60cm

DOUBLE-SIDED SHARKFIN FLYING BANNERS

	1 DISPLAY-7012	2 DISPLAY-7013	3 DISPLAY-7014
Weight	2kg	2.2kg	3.2kg
Hardware	2 x poles: aluminium	2 x poles: aluminium	3 x poles: aluminium
Frame assembled size	2m	3m	4m
Accessories	2 x rods: fibre 1 x ground spike: steel	2 x rods: fibre 1 x ground spike: steel	2 x rods: fibre 1 x ground spike: steel
Bag material	Polyester oxford	Polyester oxford	Polyester oxford
Bag size	137 x 18cm	137 x 18cm	137 x 18cm
Skin included	1 x banner skin	1 x banner skin	1 x banner skin
Material	Polyester warp knit	Polyester warp knit	Polyester warp knit
Visual size	0.98 x 2.24m	1.38 x 3.3m	1.14 x 4.4m
Features	Anti-fray	Anti-fray	Anti-fray
Branding	Double-sided sublimation	Double-sided sublimation	Double-sided sublimation
Range	★★ LEGEND RANGE	★★ LEGEND RANGE	★★ LEGEND RANGE
Refresh the banner for multiple campaigns by buying a new skin			
Reskin Code	SKIN-7012	SKIN-7013	SKIN-7014

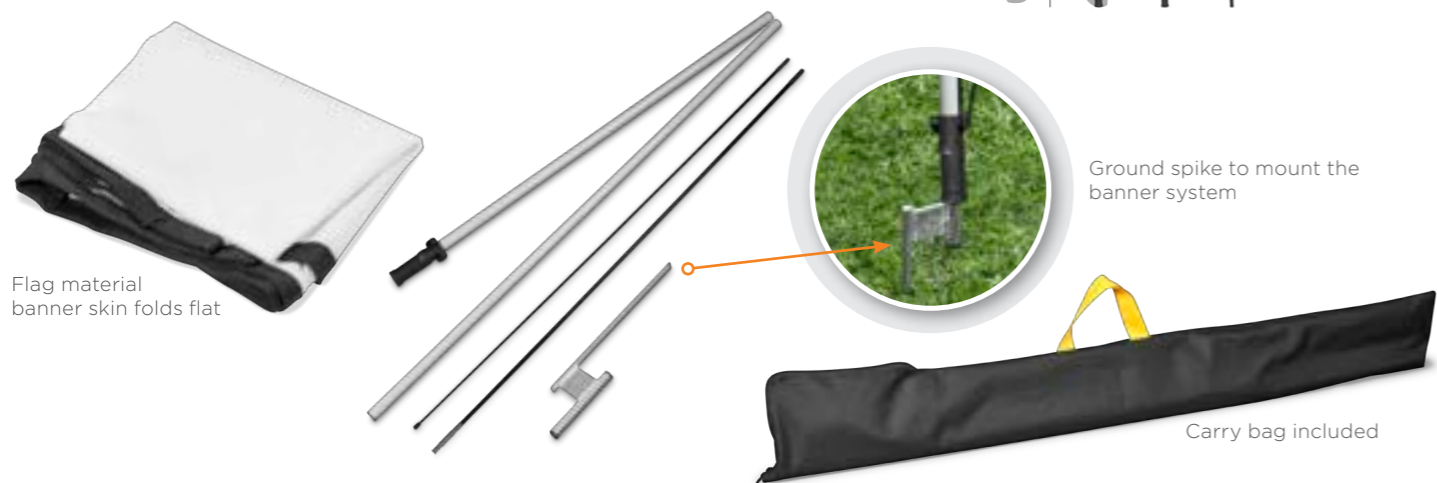
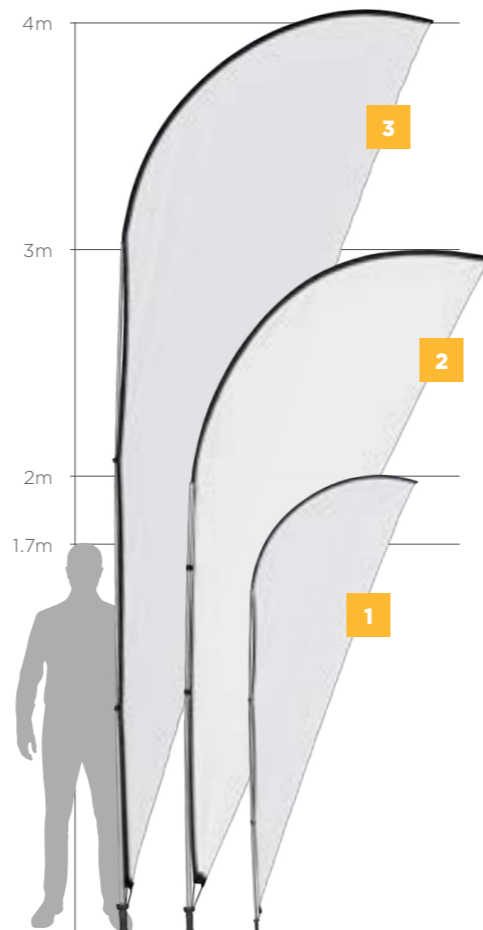

OPTIONAL EXTRAS FOR THE DOUBLE-SIDED SHARKFIN FLYING BANNERS



DISPLAY-7000

LEGEND FLYING BANNER GROUND SPIKE
ground spike: steel

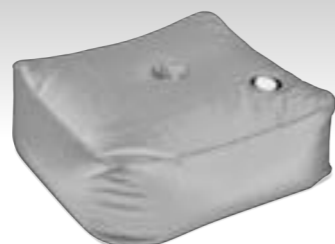

DISPLAY-7050

LEGEND FLYING BANNER 20L SQUARE WATER BASE
base: PP, refill with 20L water, collapsible

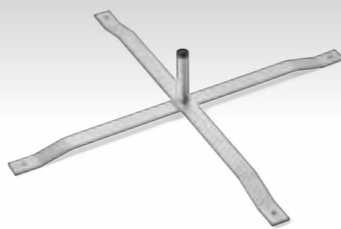

DISPLAY-7051

LEGEND FLYING BANNER SCISSOR BASE
base: steel, size: 60 x 60cm





TELESCOPIC FLYING BANNERS

	DISPLAY-7042	DISPLAY-7043	DISPLAY-7044
	Sold in sets of 2, info below is per unit		
Weight	1.8kg	2.7kg	3.5kg
Hardware	2 x poles & 1 arm: aluminium	3 x poles & 1 arm: aluminium	4 x poles & 1 arm: aluminium
Frame assembled size	2m	3m	4m
Accessories	1 x ground spike: steel	1 x ground spike: steel	1 x ground spike: steel
Bag material	Polyester oxford	Polyester oxford	Polyester oxford
Bag size	137 x 18cm	137 x 18cm	137 x 18cm
Skin included	1 x banner skin	1 x banner skin	1 x banner skin
Material	Polyester warp knit	Polyester warp knit	Polyester warp knit
Visual size	0.7 x 1.8m	0.7 x 2.5m	0.7 x 3.5m
Features	Anti-fray	Anti-fray	Anti-fray
Branding	Single-sided sublimation	Single-sided sublimation	Single-sided sublimation
Range	★★ LEGEND RANGE	★★ LEGEND RANGE	★★ LEGEND RANGE
Refresh the banner for multiple campaigns by buying a new skin (SOLD IN SETS OF 2)			
Reskin Code	SKIN-7042	SKIN-7043	SKIN-7044

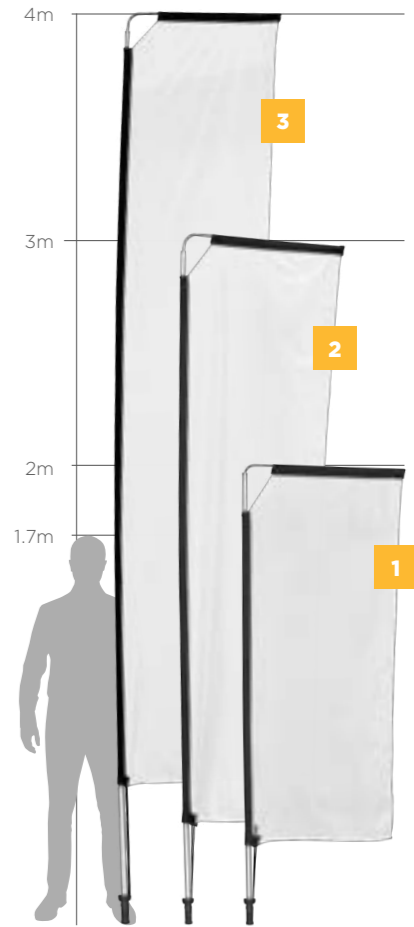

OPTIONAL EXTRAS FOR THE TELESCOPIC FLYING BANNERS



DISPLAY-7000
LEGEND FLYING BANNER GROUND SPIKE
ground spike: steel

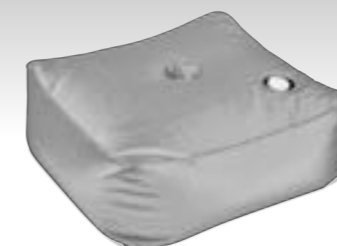

DISPLAY-7050
LEGEND FLYING BANNER 20L SQUARE WATER BASE
base: PP, refill with 20L water, collapsible

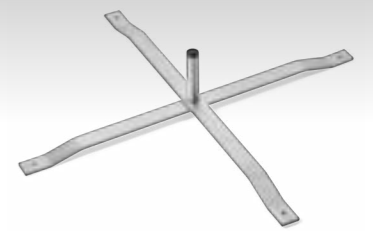

DISPLAY-7051
LEGEND FLYING BANNER SCISSOR BASE
base: steel, size: 60 x 60cm

DOUBLE-SIDED TELESCOPIC FLYING BANNERS

	DISPLAY-7052	DISPLAY-7053	DISPLAY-7054
Weight	2.1kg	2.4kg	4kg
Hardware	2 x poles & 1 arm: aluminium	3 x poles & 1 arm: aluminium	4 x poles & 1 arm: aluminium
Frame assembled size	2m	3m	4m
Accessories	1 x ground spike: steel	1 x ground spike: steel	1 x ground spike: steel
Bag material	Polyester oxford	Polyester oxford	Polyester oxford
Bag size	137 x 18cm	137 x 18cm	137 x 18cm
Skin included	1 x banner skin	1 x banner skin	1 x banner skin
Material	Polyester warp knit	Polyester warp knit	Polyester warp knit
Visual size	0.7 x 1.8m	0.7 x 2.5m	0.7 x 3.5m
Features	Anti-fray	Anti-fray	Anti-fray
Branding	Double-sided sublimation	Double-sided sublimation	Double-sided sublimation
Range	★★ LEGEND RANGE	★★ LEGEND RANGE	★★ LEGEND RANGE
Refresh the banner for multiple campaigns by buying a new skin			
Reskin Code	SKIN-7052	SKIN-7053	SKIN-7054

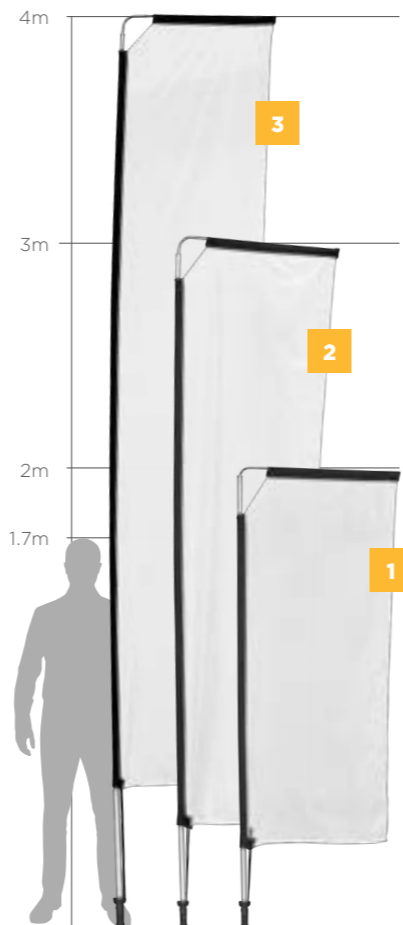

Flag material banner skin folds flat

Carry bag included

Ground spike to mount the banner system

OPTIONAL EXTRAS FOR THE DOUBLE-SIDED TELESCOPIC FLYING BANNERS



DISPLAY-7000
LEGEND FLYING BANNER GROUND SPIKE
ground spike: steel

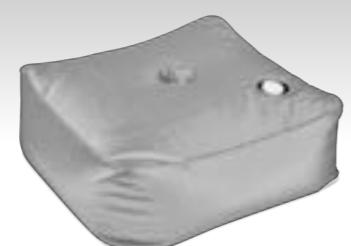

DISPLAY-7050
LEGEND FLYING BANNER 20L SQUARE WATER BASE
base: PP, refill with 20L water, collapsible

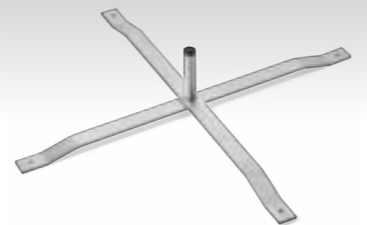

DISPLAY-7051
LEGEND FLYING BANNER SCISSOR BASE
base: steel, size: 60 x 60cm

A large blue parasol is the central focus, featuring a circular logo with a crown and the words 'BEER LIGHT' in gold. The parasol is set against a background of palm trees and a beach. In the top right corner, there is a yellow triangular graphic with two white stars. The overall scene is bright and sunny, suggesting a tropical or beachside setting.

SUBLIMATED PARASOLS

Create an inviting environment and overshadow your competition with our range of Parasols.

Ideal for restaurants, hotel courtyards, retail outlets and outdoor seating areas.

Our Parasols are manufactured with a sturdy aluminium frame and recycled plastic components to provide you with a high quality, corrosion resistant display solution.



DISPLAY-9000
Weight: 6.3kg
Hardware: 1 x pole: aluminium, PP & steel, assembled size: 2 x 2m
Slip cover: polyester oxford, 177 x 34cm
Material: 1 x roof skin, gazebo display fabric, water-resistant
Visual size: 2 x 2m
Branding: single-sided sublimation

Refresh the parasol for multiple campaigns by buying a new skin
 Reskin code: SKIN-9000

★★
LEGEND
 RANGE



Base sold separately
 (see opposite page for details)

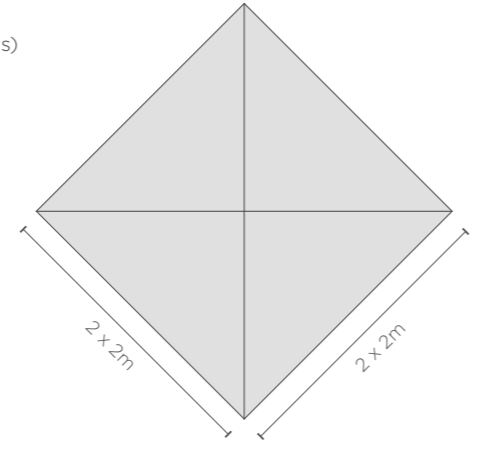

Parasol slip cover, also sold individually as DISBAG-9000

DISPLAY-9005
Weight: 6kg
Hardware: 1 x pole: aluminium, PP & steel, assembled size: 2 x 2m
 2m sliding pole, collapsible to 1.5m
Slip cover: polyester oxford, 177 x 34cm
Material: 1 x roof skin, gazebo display fabric, water-resistant
Visual size: 2 x 2m
Branding: single-sided sublimation

Refresh the parasol for multiple campaigns by buying a new skin
 Reskin code: SKIN-9000

★★
LEGEND
 RANGE

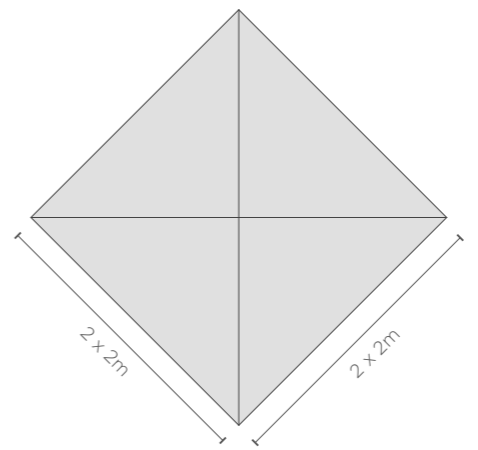

PARASOL BASE

DISPLAY-9001
PARASOL CONCRETE BASE
Weight: 28.75kg
Material: concrete & steel

Base sold separately and fits all 3 parasols:
 DISPLAY-9000, DISPLAY-9005, DISPLAY-9010



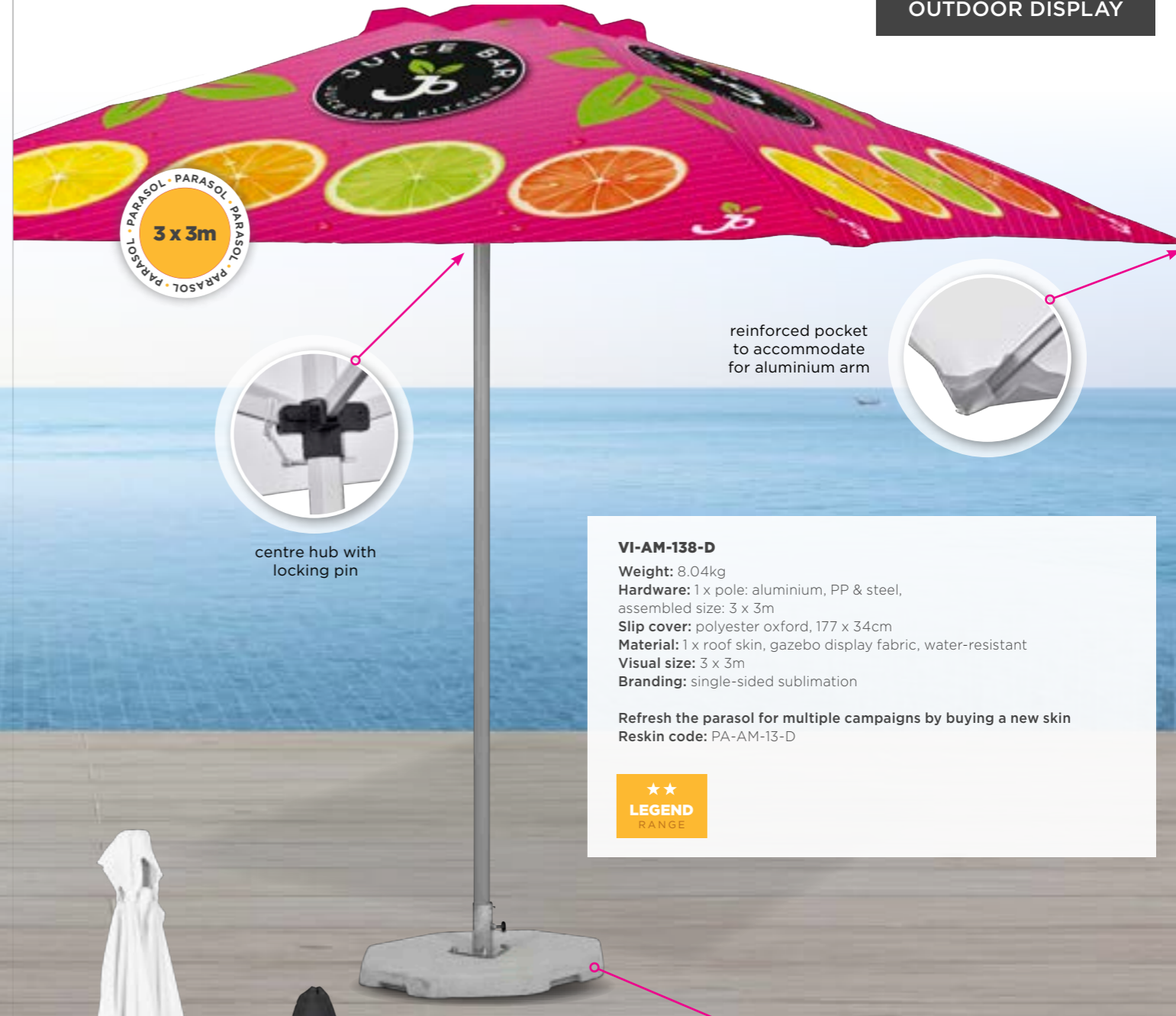

VI-AM-138-D
Weight: 8.04kg
Hardware: 1 x pole: aluminium, PP & steel, assembled size: 3 x 3m
Slip cover: polyester oxford, 177 x 34cm
Material: 1 x roof skin, gazebo display fabric, water-resistant
Visual size: 3 x 3m
Branding: single-sided sublimation

Refresh the parasol for multiple campaigns by buying a new skin
 Reskin code: PA-AM-13-D

★★
LEGEND
 RANGE

DISPLAY-9010

Weight: 7.12kg
Hardware: 1 x pole: aluminium, PP & steel, assembled size: 2.2 x 2.2m
Slip cover: polyester oxford, 177 x 34cm
Material: 1 x roof skin, gazebo display fabric, water-resistant
Visual size: 2.2 x 2.2m
Branding: single-sided sublimation

Refresh the parasol for multiple campaigns by buying a new skin
 Reskin code: SKIN-9010

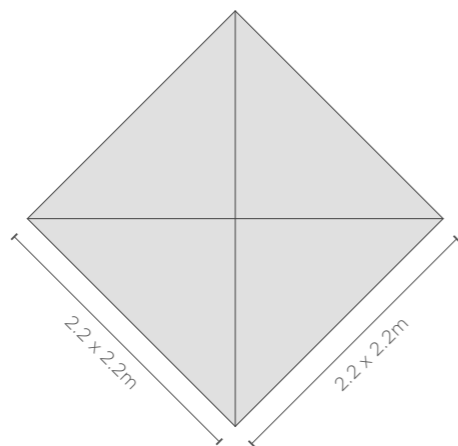

PARASOL BASE

DISPLAY-9001
PARASOL CONCRETE BASE
Weight: 28.75kg
Material: concrete & steel

Base sold separately and fits all 3 parasols:
 DISPLAY-9000, DISPLAY-9005, DISPLAY-9010



PARASOL BASE

PA-AM-16-D
PARASOL CONCRETE BASE
Weight: 50.00kg
Material: concrete & steel

Base sold separately and fits:
 VI-AM-137-D, VI-AM-138-D

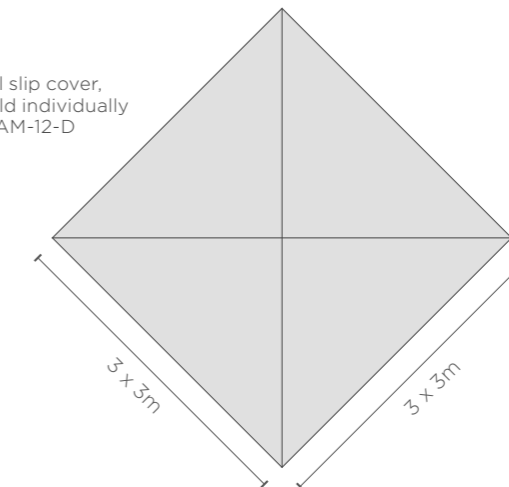
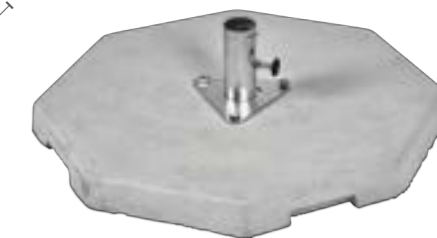



FADE RESISTANT PARASOLES

Our Fade Resistant Displays are printed with state-of-the-art Latex Gen-4 inks, boasting the widest colour gamut on the market.

This allows us to print the widest range of colours within the colour spectrum and produce the most vibrant and vivid print results.

The inks have a low environmental impact, are UV stable and scratch resistant, providing great durability for long-term outdoor exposure.

Premium polyester fabric with a unique print-guard coating is used for all of our Fade Resistant Parasoles.

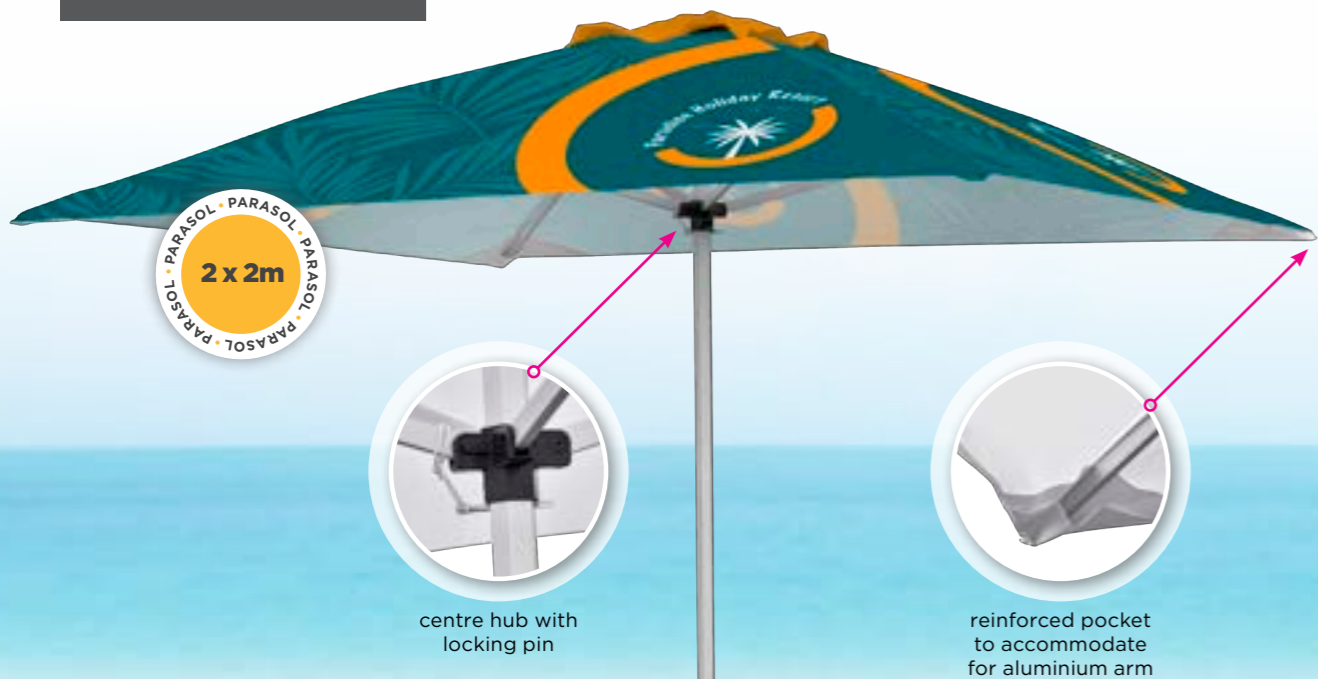

2 x 2m



centre hub with locking pin



reinforced pocket to accommodate for aluminium arm

VI-AM-139-D

Weight: 6.3kg
Hardware: 1 x pole: aluminium, PP & steel, assembled size: 2 x 2m
Slip cover: polyester oxford, 177 x 34cm
Material: print-guard polyester, water resistant
Visual size: 2 x 2m
Branding: latex gen-4 printing

Refresh the parasol for multiple campaigns by buying a new skin
 Reskin code: PA-AM-14-D



Base sold separately (see opposite page for details)

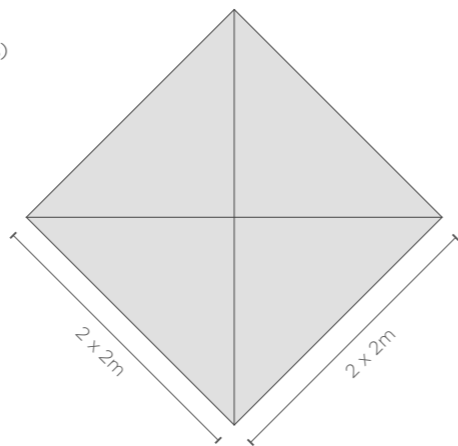

Parasol slip cover, also sold individually as DISBAG-9000



2 x 2m



centre hub with locking pin

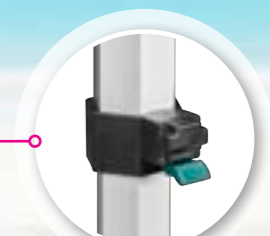

2m sliding pole with quick release lock, collapsible to 1.5m high

Parasol slip cover, also sold individually as DISBAG-9000



VI-AM-140-D

Weight: 6kg
Hardware: 1 x pole: aluminium, PP & steel, assembled size: 2 x 2m, 2m sliding pole, collapsible to 1.5m
Slip cover: polyester oxford, 177 x 34cm
Material: print-guard polyester, water resistant
Visual size: 2 x 2m
Branding: latex gen-4 printing

Refresh the parasol for multiple campaigns by buying a new skin
 Reskin code: PA-AM-14-D

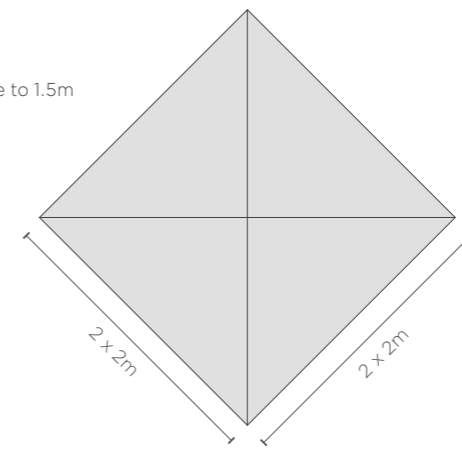

PARASOL BASE

DISPLAY-9001
PARASOL CONCRETE BASE
Weight: 28.75kg
Material: concrete & steel

Base sold separately and fits all 3 parasols:
 VI-AM-139-D, VI-AM-140-D, VI-AM-141-D

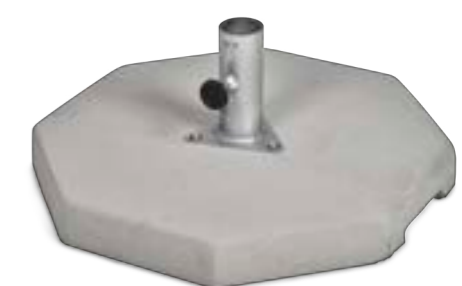



2.2m x 2.2m



centre hub with locking pin



reinforced pocket to accommodate for aluminium arm



Parasol slip cover, also sold individually as DISBAG-9000

PARASOL BASE



DISBAG-9001
PARASOL CONCRETE BASE
Weight: 28.75kg
Material: concrete & steel
 Base sold separately and fits all 3 parasols:
 VI-AM-139-D, VI-AM-140-D, VI-AM-141-D

VI-AM-141-D
Weight: 7.12kg
Hardware: 1 x pole: aluminium, PP & steel, assembled size: 2.2 x 2.2m
Slip cover: polyester oxford, 177 x 34cm
Material: print-guard polyester, water resistant
Visual size: 2.2 x 2.2m
Branding: latex gen-4 printing

Refresh the parasol for multiple campaigns by buying a new skin
 Reskin code: PA-AM-15-D

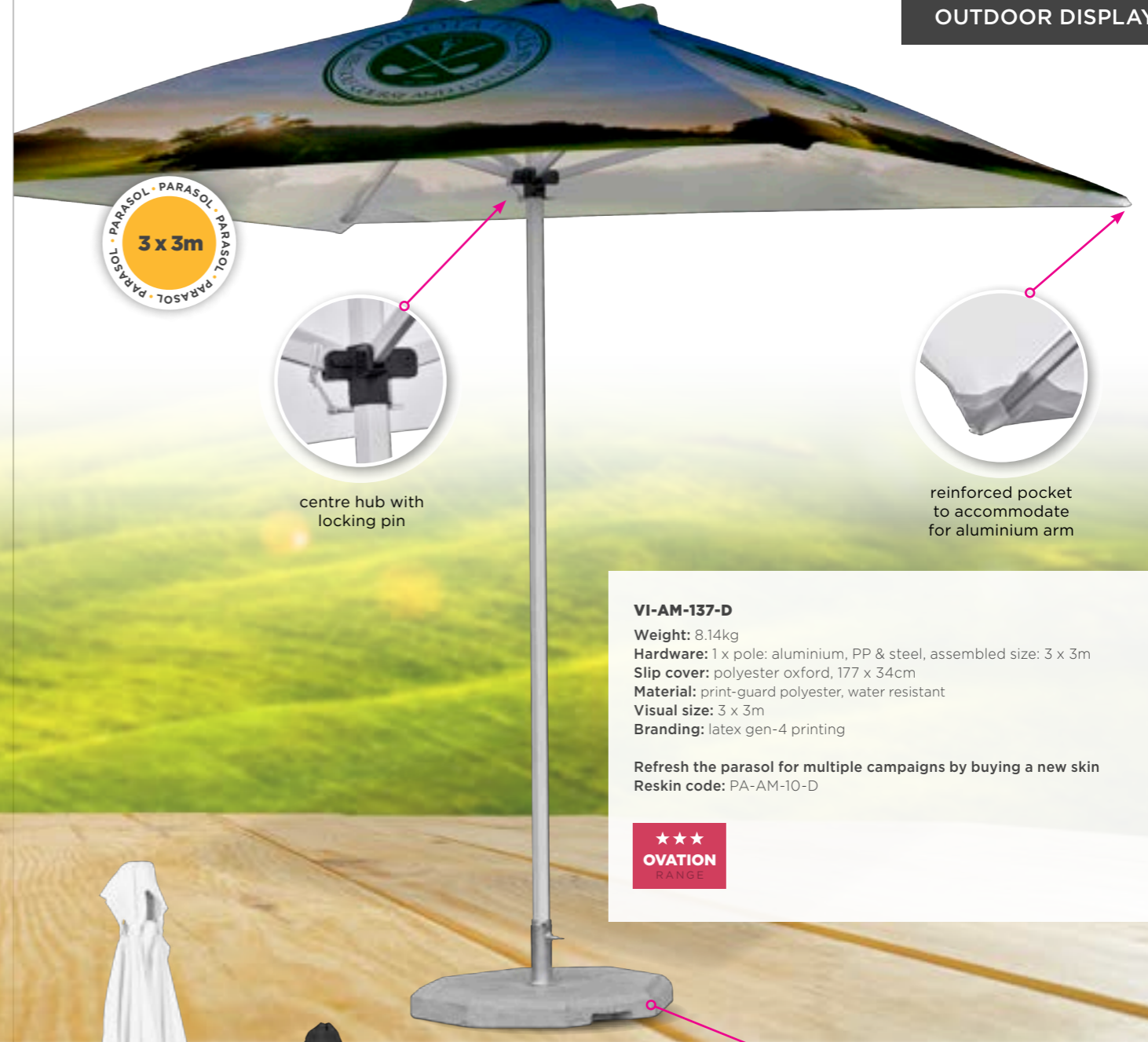
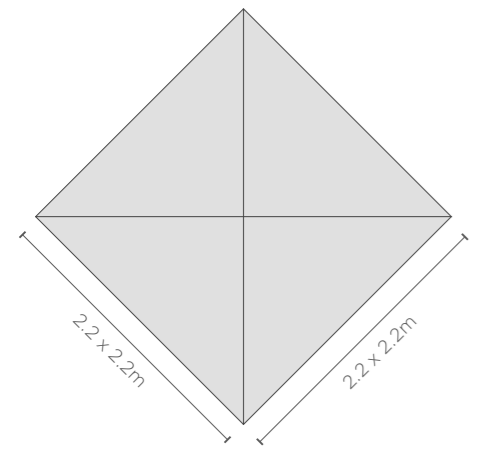

3 x 3m



centre hub with locking pin



reinforced pocket to accommodate for aluminium arm



Parasol slip cover, also sold individually as PA-AM-12-D

VI-AM-137-D
Weight: 8.14kg
Hardware: 1 x pole: aluminium, PP & steel, assembled size: 3 x 3m
Slip cover: polyester oxford, 177 x 34cm
Material: print-guard polyester, water resistant
Visual size: 3 x 3m
Branding: latex gen-4 printing
 Refresh the parasol for multiple campaigns by buying a new skin
 Reskin code: PA-AM-10-D



PARASOL BASE



PA-AM-16-D
PARASOL CONCRETE BASE
Weight: 50.00kg
Material: concrete & steel
 Base sold separately and fits:
 VI-AM-137-D, VI-AM-138-D

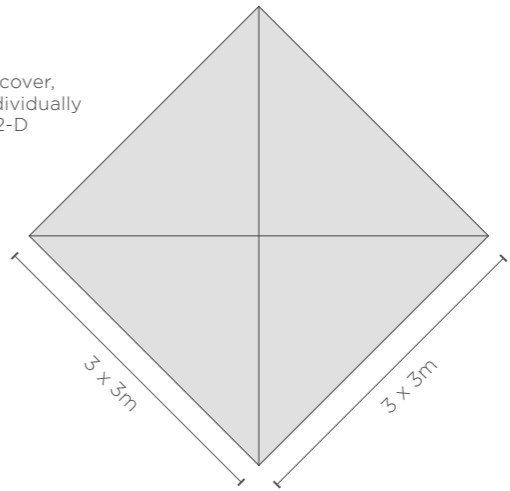



SUBLIMATED GAZEBOS

Gazebos are suitable for brand activations, product launches, markets, sporting events, marathons, schools, festivals, golf days and so much more.

All of our Gazebos fall within the Ovation family - defined by premium quality construction and durability, at an extremely competitive price point.

Available in a range of popular sizes our standard Gazebos include the following components:

- 1 x durable and lightweight aluminium frame
- 1 x water-resistant polyester roof
- 1 x polyester carry bag for portability and convenient storage.

CUSTOMISE YOUR GAZEBO

Half and Full Wall Skins are available for all of the Gazebos in this range - allowing you to customise and configure your Gazebo to suit your requirements and maximise your brand exposure. The wall skins easily attach to the structure, making this display solution ideal for interchangeable artwork - offering a great ROI for your business.

The wall skins are branded on one side only, using our state-of-the-art sublimation branding process to produce vibrant results.



SUBLIMATED GAZEBO 1 X 1M KIOSK

SPECIFICATIONS

- Weight:** 11kg
- Hardware:** 1 x frame: aluminium, assembled size: 1 x 1m, quick assembly, portable
- Table:** ABS top with aluminium supports 100 x 29 x 3cm
- Bag included:** polyester oxford, size: 123 x 18 x 18cm
- Fabric:** gazebo display fabric, fitted 600D water head, water resistant
- Branding:** single-sided sublimation
- Half wall visual size:** 1 x 1m
- Full wall visual size:** 1 x 1.9m



WALL CONFIGURATION	DISPLAY CODE
No walls	DISPLAY-2000
1 x half wall skin	DISPLAY-2002
3 x half wall skins	DISPLAY-2004
3 x half wall skins, 1 x full wall skin	DISPLAY-2006

Refresh the gazebo for multiple campaigns by buying a new skin	
Roof Reskin Code	SKIN-2000
Full Wall Reskin Code	SKIN-2002
Half Wall Reskin Code	SKIN-2004

The compact design and flat roof structure makes this gazebo perfect for indoor and outdoor activations that require quick setups and lend themselves to promotions and brand activations in forecourts and other small areas.



4 attached loops for additional stability, used to secure gazebo with ground pegs and ropes (not included) see TOOLKIT-2000



Mobile kiosk includes ABS tabletop with aluminium supports



Aluminium hexagonal leg profile for superior strength & pre-punched feet to easily secure gazebo with ground pegs

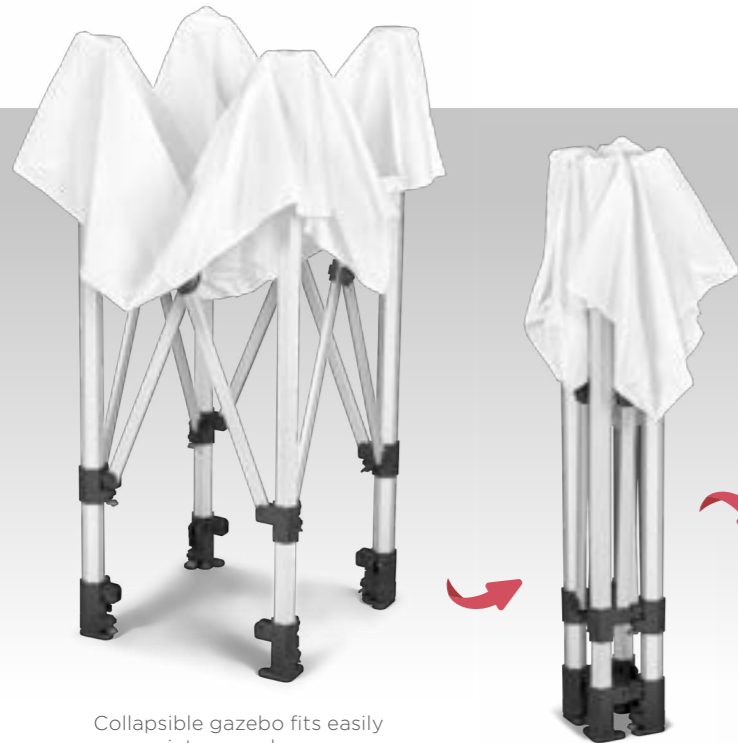

Collapsible gazebo fits easily into carry bag

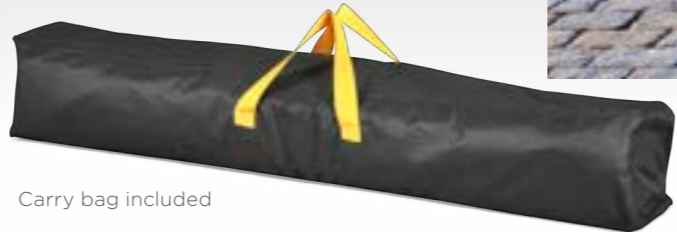

Carry bag included



GAZEBO FOOTPRINT

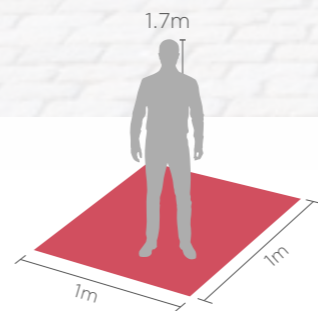

Images shown are for DISPLAY-2004

Branding is visible on one side only, walls can face inwards (A) or outwards (B)

SUBLIMATED GAZEBO 1.5 X 1.5M KIOSK

SPECIFICATIONS

- Weight:** 8kg
- Hardware:** 1 x frame: aluminium, assembled size: 1.5 x 1.5m, quick assembly, portable
- Bag included:** polyester oxford, size: 156 x 23 x 21cm, webbing handles
- Toolkit included:** 1 x mallet: rubber & wood, 4 x ropes: nylon, 4 x frame pegs: steel, 4 x rope pegs: steel
- Fabric:** gazebo display fabric, fitted 600D water head, water resistant
- Branding:** single-sided sublimation
- Half wall visual size:** 1.5 x 1m
- Full wall visual size:** 1.5 x 1.9m



WALL CONFIGURATION	DISPLAY CODE
No walls	DISPLAY-2020
1 x full wall skin	DISPLAY-2022
2 x full wall skins	DISPLAY-2024
3 x full wall skins	DISPLAY-2026
1 x half wall skin	DISPLAY-2028
2 x half wall skins	DISPLAY-2030
3 x half wall skins	DISPLAY-2032
4 x half wall skins	DISPLAY-2034
1 x half wall skin, 1 x full wall skin	DISPLAY-2035
2 x half wall skins, 1 x full wall skin	DISPLAY-2036
3 x half wall skins, 1 x full wall skin	DISPLAY-2038

Refresh the gazebo for multiple campaigns by buying a new skin	
Roof Reskin Code	SKIN-2020
Full Wall Reskin Code	SKIN-2022
Half Wall Reskin Code	SKIN-2024

The compact design and flat roof structure makes this gazebo perfect for indoor and outdoor activations that require quick setups and lend themselves to promotions and brand activations in forecourts and other small areas.



4 attached loops for additional stability, used to secure gazebo with ground pegs and ropes

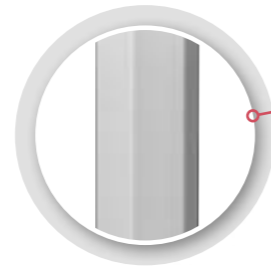

Aluminium hexagonal leg profile for superior strength



Pre-punched feet to easily secure gazebo with ground pegs



Branding is visible on one side only, walls can face inwards (A) or outwards (B)

Images shown are for DISPLAY-2036

GAZEBO FOOTPRINT

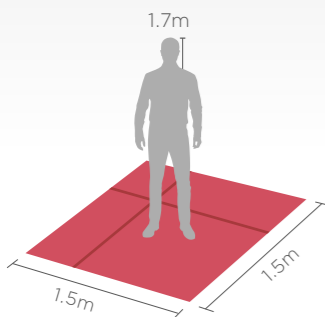

Collapsible gazebo fits easily into carry bag

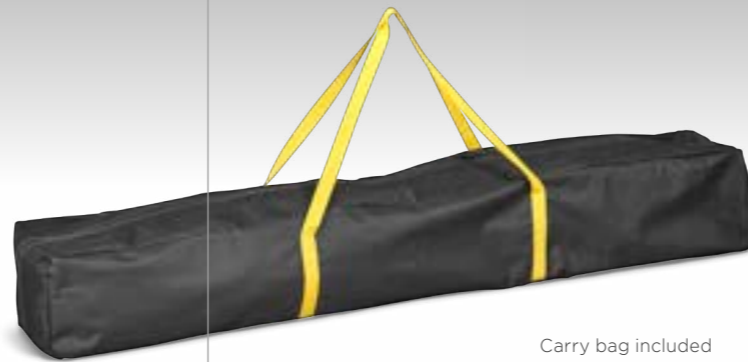
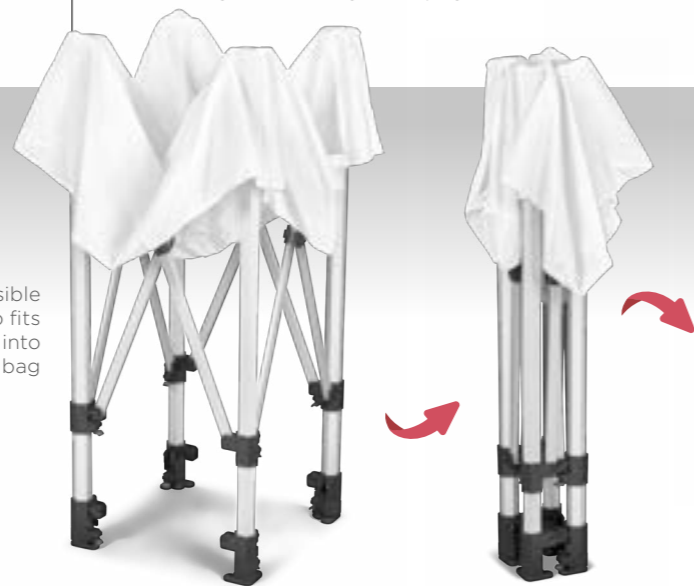

Carry bag included
(ALSO SOLD INDIVIDUALLY AS DISBAG-2020)



Toolkit included: 1 x mallet, 4 x ropes, 4 x frame pegs, 4 x rope pegs
(ALSO SOLD INDIVIDUALLY AS TOOLKIT-2000)

SUBLIMATED GAZEBO 2 X 2M

SPECIFICATIONS

- Weight:** 14kg
- Hardware:** 1 x frame: aluminium, assembled size: 2 x 2m, quick assembly, portable
- Slip over bag included:** polyester oxford, size: 158 x 28 x 28cm, webbing handles
- Toolkit included:** 1 x mallet: rubber & wood, 4 x ropes: nylon, 4 x frame pegs: steel, 4 x rope pegs: steel
- Fabric:** gazebo display fabric, fitted 600D water head, water resistant
- Branding:** single-sided sublimation
- Half wall visual size:** 2 x 1m
- Full wall visual size:** 2 x 1.9m



WALL CONFIGURATION	DISPLAY CODE
No walls	DISPLAY-2040
1 x full wall skin	DISPLAY-2042
2 x full wall skins	DISPLAY-2044
3 x full wall skins	DISPLAY-2045
1 x half wall skin	DISPLAY-2046
2 x half wall skins	DISPLAY-2048
3 x half wall skins	DISPLAY-2050
4 x half wall skins	DISPLAY-2052
1 x full wall skin, 1 x half wall skin	DISPLAY-2054
1 x full wall skin, 2 x half wall skins	DISPLAY-2056
1 x full wall skin, 3 x half wall skins	DISPLAY-2058

Refresh the gazebo for multiple campaigns by buying a new skin	
Roof Reskin Code	SKIN-2040
Full Wall Reskin Code	SKIN-2042
Half Wall Reskin Code	SKIN-2044



Collapsible gazebo fits easily into carry bag



Toolkit included: 1 x mallet, 4 x ropes, 4 x frame pegs, 4 x rope pegs

(ALSO SOLD INDIVIDUALLY AS TOOLKIT-2000)



Slip over bag included
(ALSO SOLD INDIVIDUALLY AS DISBAG-2040)

BAG ON WHEELS FOR 2m GAZEBO
SOLD INDIVIDUALLY AS DISPLAY-2001

Pitched roof gazebo, perfect for outdoor events and activations where a smaller footprint is required.



4 attached loops for additional stability, used to secure gazebo with ground pegs and ropes

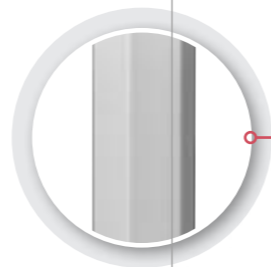

Aluminium hexagonal leg profile for superior strength



Pre-punched feet to easily secure gazebo with ground pegs

GAZEBO FOOTPRINT

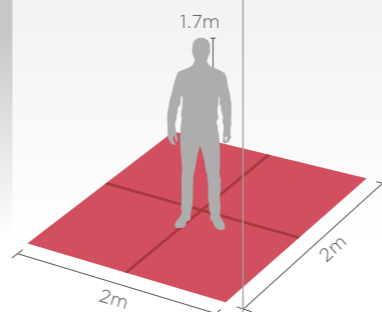

Image shown is for DISPLAY-2052

Branding is visible on one side only, walls can face inwards or outwards

**SUBLIMATED GAZEBO
2 X 2M - PETITE FRAME**

SPECIFICATIONS

- Weight:** 13kg
- Hardware:** 1 x frame: aluminium, assembled size: 2 x 2m, quick assembly, portable, compact
- Slip over bag included:** polyester oxford, size: 122 x 28 x 28cm, webbing handles
- Toolkit included:** 1 x mallet: rubber & wood, 4 x ropes: nylon, 4 x frame pegs: steel, 4 x rope pegs: steel
- Fabric:** gazebo display fabric, fitted 600D water head, water resistant
- Branding:** single-sided sublimation
- Half wall visual size:** 2 x 1m
- Full wall visual size:** 2 x 1.85m



WALL CONFIGURATION	DISPLAY CODE
No walls	DISPLAY-2140
1 x full wall skin	DISPLAY-2142
2 x full wall skins	DISPLAY-2144
3 x full wall skins	DISPLAY-2145
1 x half wall skin	DISPLAY-2146
2 x half wall skins	DISPLAY-2148
3 x half wall skins	DISPLAY-2150
4 x half wall skins	DISPLAY-2152
1 x half wall skin, 1 x full wall skin	DISPLAY-2154
2 x half wall skins, 1 x full wall skin	DISPLAY-2156
3 x half wall skins, 1 x full wall skin	DISPLAY-2158

Refresh the gazebo for multiple campaigns by buying a new skin	
Roof Reskin Code	SKIN-2040
Full Wall Reskin Code	SKIN-2140
Half Wall Reskin Code	SKIN-2044



Collapsible gazebo fits easily into carry bag



Slip over bag included
(ALSO SOLD INDIVIDUALLY AS DISBAG-2140)



Toolkit included: 1 x mallet, 4 x ropes, 4 x frame pegs, 4 x rope pegs
(ALSO SOLD INDIVIDUALLY AS TOOLKIT-2000)



4 attached loops for additional stability, used to secure gazebo with ground pegs and ropes

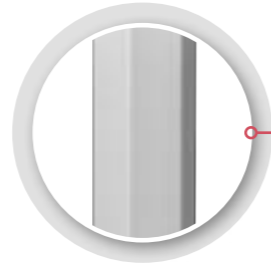

Aluminium hexagonal leg profile for superior strength



Pre-punched feet to easily secure gazebo with ground pegs

This gazebo is perfect for brand activations, product launches, sporting events and mobile retail shops to mention a few. The Petite Gazebo features extra collapsible legs that slide in making it compact and portable allowing for easy transportation.



GAZEBO FOOTPRINT

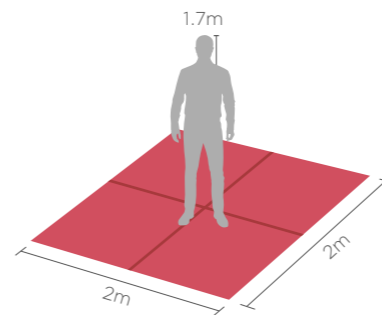

Image shown is for DISPLAY-2156

Branding is visible on one side only, walls can face inwards or outwards

SUBLIMATED GAZEBO 3 X 3M

SPECIFICATIONS

- Weight:** 19kg
- Hardware:** 1 x frame: aluminium, assembled size: 3 x 3m, quick assembly, portable
- Slip over bag included:** polyester oxford, size: 158 x 28 x 28cm, webbing handles
- Toolkit Included:** 1 x mallet: rubber & wood, 4 x ropes: nylon, 4 x frame pegs: steel, 4 x rope pegs: steel
- Fabric:** gazebo display fabric, fitted 600D water head, water resistant
- Branding:** single-sided sublimation
- Half wall visual size:** 3 x 1m
- Full wall visual size:** 3 x 1.9m



WALL CONFIGURATION	DISPLAY CODE
No walls	DISPLAY-2060
1 x full wall skin	DISPLAY-2062
2 x full wall skins	DISPLAY-2064
3 x full wall skins	DISPLAY-2065
1 x half wall skin	DISPLAY-2066
2 x half wall skins	DISPLAY-2068
3 x half wall skins	DISPLAY-2070
4 x half wall skins	DISPLAY-2072
1 x half wall skin, 1 x full wall skin	DISPLAY-2074
2 x half wall skins, 1 x full wall skin	DISPLAY-2076
3 x half wall skins, 1 x full wall skin	DISPLAY-2078

Refresh the gazebo for multiple campaigns by buying a new skin	
Roof Reskin Code	SKIN-2060
Full Wall Reskin Code	SKIN-2062
Half Wall Reskin Code	SKIN-2064

With a slightly bigger footprint, this gazebo size is ideal for brand activations, product launches, sporting events and mobile retail to mention a few.



4 attached loops for additional stability, used to secure gazebo with ground pegs and ropes

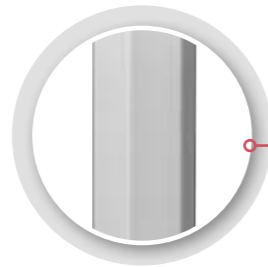

Aluminium hexagonal leg profile for superior strength



Pre-punched feet to easily secure gazebo with ground pegs



Image shown is for DISPLAY-2065

Branding is visible on one side only, walls can face inwards or outwards

GAZEBO FOOTPRINT

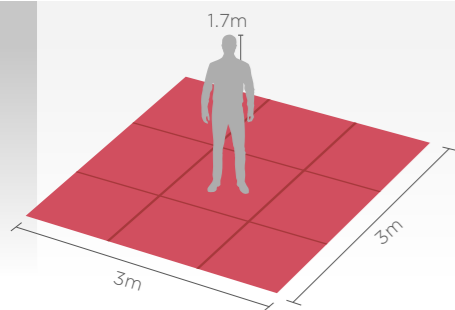

Collapsible gazebo fits easily into carry bag



Slip over bag included
(ALSO SOLD INDIVIDUALLY AS DISBAG-2040)

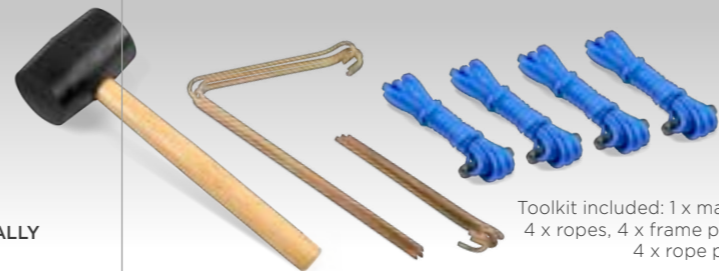

Toolkit included: 1 x mallet, 4 x ropes, 4 x frame pegs, 4 x rope pegs

(ALSO SOLD INDIVIDUALLY AS TOOLKIT-2000)



BAG ON WHEELS FOR 3m GAZEBO
SOLD INDIVIDUALLY AS DISPLAY-2001

SUBLIMATED GAZEBO
4.5 X 3M

SPECIFICATIONS

- Weight:** 25kg
- Hardware:** 1 x frame: aluminium, assembled size: 4.5 x 3m, quick assembly, portable
- Slip over bag included:** polyester oxford, size: 158 x 29 x 31cm, webbing handles
- Toolkit included:** 1 x mallet: rubber & wood, 4 x ropes: nylon, 4 x frame pegs: steel, 4 x rope pegs: steel
- Fabric:** gazebo display fabric, fitted 600D water head, water resistant
- Branding:** single-sided sublimation
- Short half wall visual size:** 3 x 1m
- Long full wall visual size:** 4.5 x 1.9m
- Short full wall visual size:** 3 x 1.9m



WALL CONFIGURATION	DISPLAY CODE
No walls	DISPLAY-2080
1 x long full wall skin	DISPLAY-2082
2 x long full wall skins	DISPLAY-2084
1 x long full wall skin, 1 x short full wall skin	DISPLAY-2085
1 x long full wall skin, 2 x short half wall skins	DISPLAY-2086
1 x short full wall skin	DISPLAY-2088
2 x short full wall skins	DISPLAY-2090
2 x short half wall skins	DISPLAY-2092
1 x short half wall skin, 1 x long full wall skin	DISPLAY-2094

Refresh the gazebo for multiple campaigns by buying a new skin	
Roof Reskin Code	SKIN-2080
Long Full Wall Reskin Code	SKIN-2082
Short Full Wall Reskin Code	SKIN-2085
Short Half Wall Reskin Code	SKIN-2084

GAZEBO FOOTPRINT

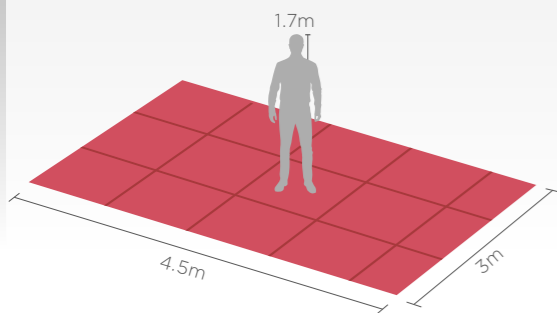

This gazebo has a slightly bigger footprint, accommodating for extra retail or display space. Perfectly fits 2 trestle tables under roof and big enough to fit 1 vehicle. That extra space might come in handy depending on the activation, product launch or event at hand.



4 attached loops for additional stability, used to secure gazebo with ground pegs and ropes



Collapsible gazebo fits easily into carry bag

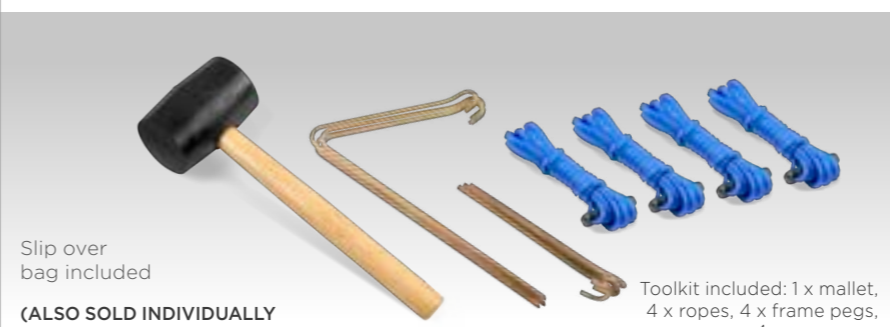

Slip over bag included
(ALSO SOLD INDIVIDUALLY AS DISBAG-2080)

Toolkit included: 1 x mallet, 4 x ropes, 4 x frame pegs, 4 x rope pegs

(ALSO SOLD INDIVIDUALLY AS TOOLKIT-2000)

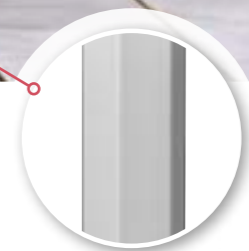

Aluminium hexagonal leg profile for superior strength



Pre-punched feet to easily secure gazebo with ground pegs

Image shown is for DISPLAY-2085

Branding is visible on one side only, walls can face inwards or outwards

SUBLIMATED GAZEBO
6 X 3M

SPECIFICATIONS

- Weight:** 32kg
- Hardware:** 1 x frame: aluminium, assembled size: 6 x 3m, quick assembly, portable
- Bag included:** polyester oxford, size: 158 x 28 x 43cm, webbing handles
- Toolkit Included:** 1 x mallet: rubber & wood, 6 x ropes: nylon, 6 x frame pegs: steel, 4 x rope pegs: steel
- Fabric:** gazebo display fabric, fitted 600D water head, water resistant
- Branding:** single-sided sublimation
- Short half wall visual size:** 3 x 1m
- Long full wall visual size:** 6 x 1.9m
- Short full wall visual size:** 3 x 1.9m



WALL CONFIGURATION	DISPLAY CODE
No walls	DISPLAY-2010
1 x long full wall skin	DISPLAY-2011
2 x long full wall skins	DISPLAY-2012
1 x long full wall skin, 1 x short full wall skin	DISPLAY-2013
1 x long full wall skin, 2 x short half wall skins	DISPLAY-2014
1 x short full wall skin	DISPLAY-2015
2 x short full wall skins	DISPLAY-2016
2 x short half wall skins	DISPLAY-2017
1 x short half wall skin, 1 x long full wall skin	DISPLAY-2018

Refresh the gazebo for multiple campaigns by buying a new skin	
Roof Reskin Code	SKIN-2010
Long Full Wall Reskin Code	SKIN-2012
Short Full Wall Reskin Code	SKIN-2015
Short Half Wall Reskin Code	SKIN-2014

GAZEBO FOOTPRINT

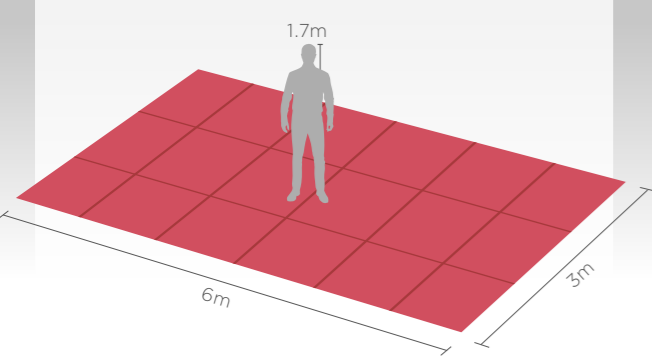

Collapsible gazebo fits easily into carry bag



Slip over bag included

(ALSO SOLD INDIVIDUALLY AS DISBAG-2010)

Toolkit included:
1 x mallet, 6 x ropes,
6 x frame pegs, 6 x rope pegs

(ALSO SOLD INDIVIDUALLY AS TOOLKIT-2010)

From outdoor events to corporate functions, this lightweight gazebo is the perfect display solution. It is fully collapsible and easy to setup, not mention fully customisable in terms of the number of walls and branding options. Branded Gazebos are a popular and affordable means of advertising.



4 attached loops for additional stability, used to secure gazebo with ground pegs and ropes

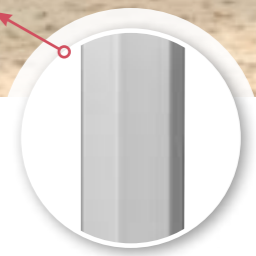

Aluminium hexagonal leg profile for superior strength



Pre-punched feet to easily secure gazebo with ground pegs

Image shown is for DISPLAY-2011

Branding is visible on one side only, walls can face inwards or outwards



FADE RESISTANT GAZEBOS

Our Fade Resistant Displays are printed with state-of-the-art Latex Gen-4 inks, boasting the widest colour gamut on the market.

This allows us to print the widest range of colours within the colour spectrum and produce the most vibrant and vivid print results.

The inks have a low environmental impact, are UV stable and scratch resistant, providing great durability for long-term outdoor exposure.

Premium polyester fabric with a unique print-guard coating is used for all of our Fade Resistant Gazebos.



FADE RESISTANT GAZEBO 1 X 1M KIOSK

SPECIFICATIONS

Weight: 11kg

Hardware: 1 x frame: aluminium, assembled size: 1 x 1m, quick assembly, portable

Table: ABS top with aluminium supports 100 x 29 x 3cm

Bag included: polyester oxford, size: 123 x 18 x 18cm

Fabric: print-guard polyester, water resistant

Branding: single-sided, latex gen-4 printing

Half wall visual size: 1 x 1m

Full wall visual size: 1 x 1.9m



WALL CONFIGURATION	DISPLAY CODE
No walls	VI-AM-142-D
1 x half wall skin	VI-AM-143-D
3 x half wall skins	VI-AM-144-D
3 x half wall skins, 1 x full wall skin	VI-AM-145-D

Refresh the gazebo for multiple campaigns by buying a new skin	
Roof Reskin Code	GZ-AM-38-D
Full Wall Reskin Code	GZ-AM-40-D
Half Wall Reskin Code	GZ-AM-39-D

The compact design and flat roof structure makes this gazebo perfect for indoor and outdoor activations that require quick setups and lend themselves to promotions and brand activations in forecourts and other small areas.



4 attached loops for additional stability, used to secure gazebo with ground pegs and ropes (not included) see TOOLKIT-2000



Mobile kiosk includes ABS tabletop with aluminium supports



Aluminium hexagonal leg profile for superior strength & pre-punched feet to easily secure gazebo with ground pegs

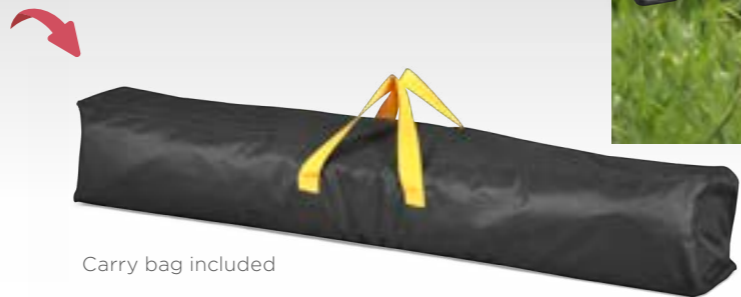

Carry bag included

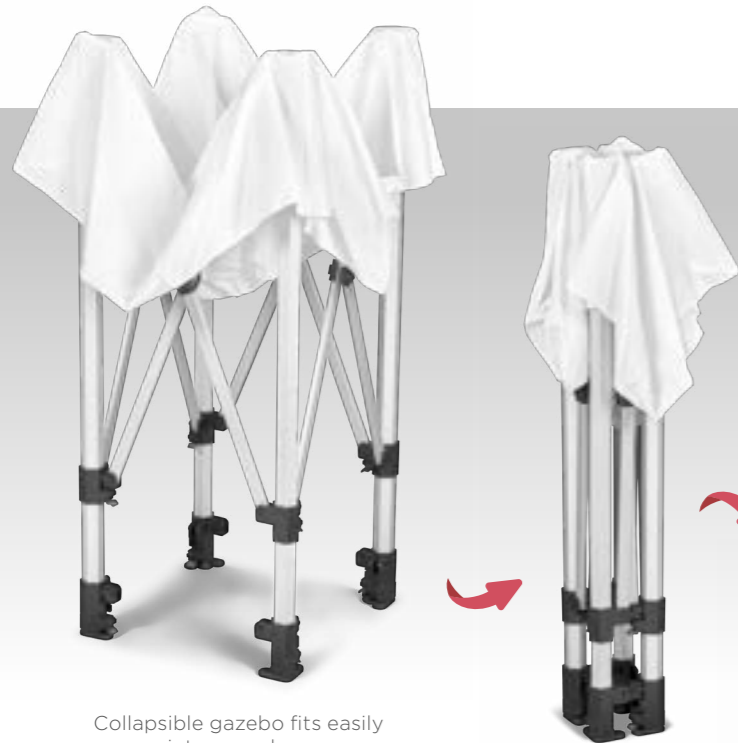

Collapsible gazebo fits easily into carry bag



B

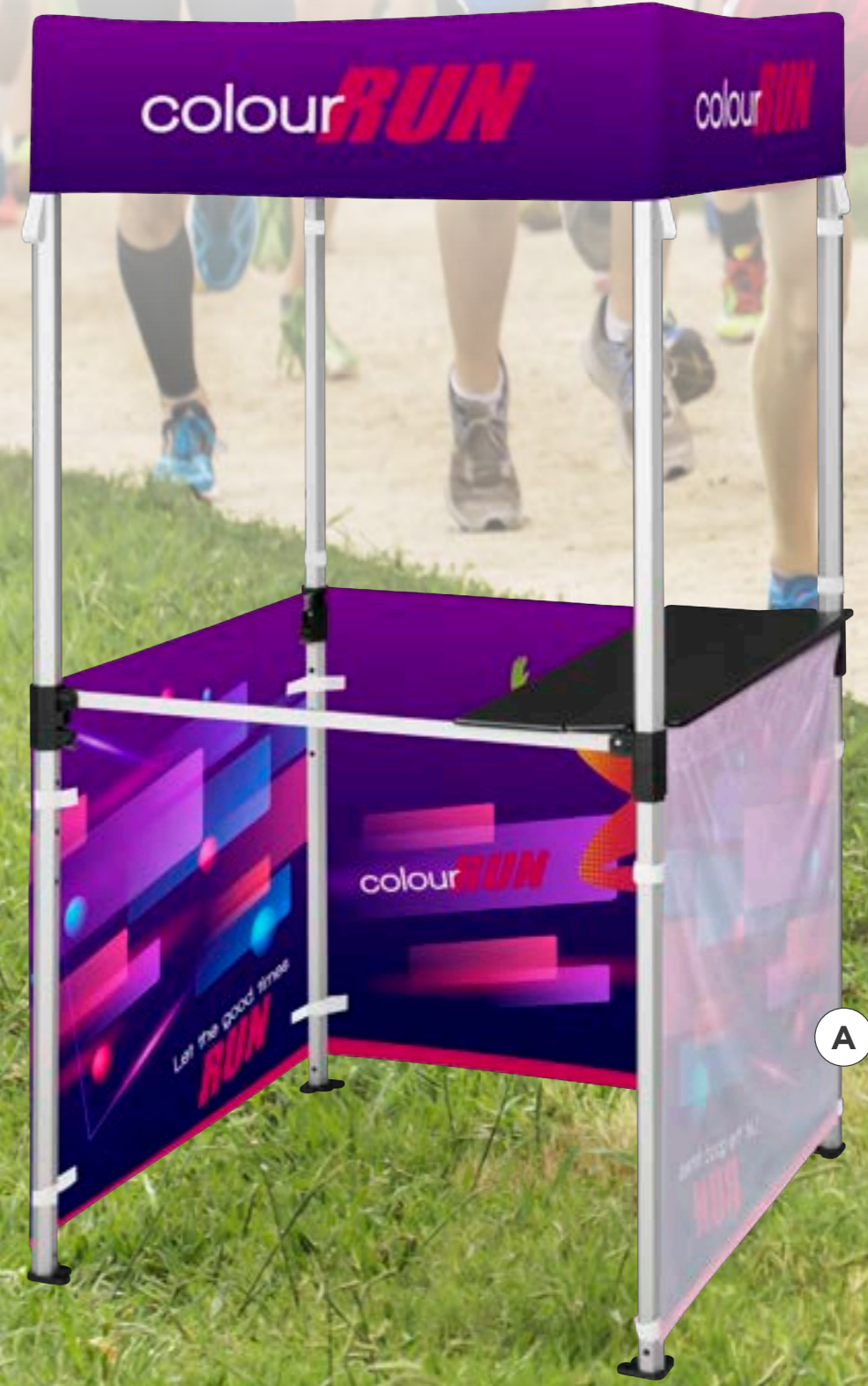

A

GAZEBO FOOTPRINT

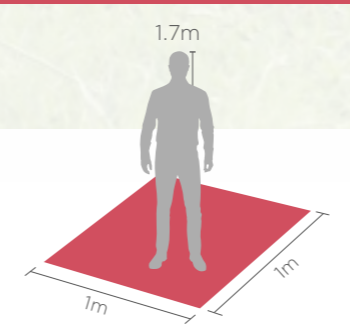

Images shown are for VI-AM-144-D

Branding is visible on one side only, walls can face inwards (A) or outwards (B)

FADE RESISTANT GAZEBO 1.5 X 1.5M KIOSK

SPECIFICATIONS

- Weight:** 8kg
- Hardware:** 1 x frame: aluminium, assembled size: 1.5 x 1.5m, quick assembly, portable
- Bag included:** polyester oxford, size: 156 x 23 x 21cm, webbing handles
- Toolkit included:** 1 x mallet: rubber & wood, 4 x ropes: nylon, 4 x frame pegs: steel, 4 x rope pegs: steel
- Fabric:** print-guard polyester, water resistant
- Branding:** single-sided, latex gen-4 printing
- Half wall visual size:** 1.5 x 1m
- Full wall visual size:** 1.5 x 1.9m



WALL CONFIGURATION	DISPLAY CODE
No walls	VI-AM-169-D
1 x full wall skin	VI-AM-170-D
2 x full wall skins	VI-AM-172-D
3 x full wall skins	VI-AM-174-D
1 x half wall skin	VI-AM-177-D
2 x half wall skins	VI-AM-179-D
3 x half wall skins	VI-AM-184-D
4 x half wall skins	VI-AM-186-D
1 x half wall skin, 1 x full wall skin	VI-AM-188-D
2 x half wall skins, 1 x full wall skin	VI-AM-192-D
3 x half wall skins, 1 x full wall skin	VI-AM-193-D

Refresh the gazebo for multiple campaigns by buying a new skin	
Roof Reskin Code	GZ-AM-45-D
Full Wall Reskin Code	GZ-AM-46-D
Half Wall Reskin Code	GZ-AM-47-D

The compact design and flat roof structure makes this gazebo perfect for indoor and outdoor activations that require quick setups and lend themselves to promotions and brand activations in forecourts and other small areas.



4 attached loops for additional stability, used to secure gazebo with ground pegs and ropes

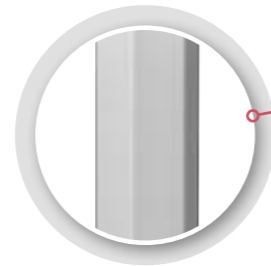

Aluminium hexagonal leg profile for superior strength



Pre-punched feet to easily secure gazebo with ground pegs



Branding is visible on one side only, walls can face inwards (A) or outwards (B)

Images shown are for VI-AM-192-D

GAZEBO FOOTPRINT

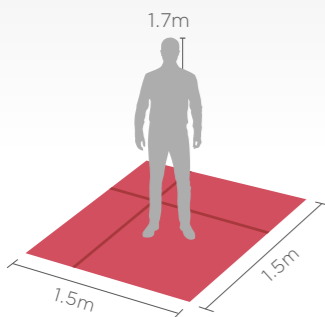

Collapsible gazebo fits easily into carry bag

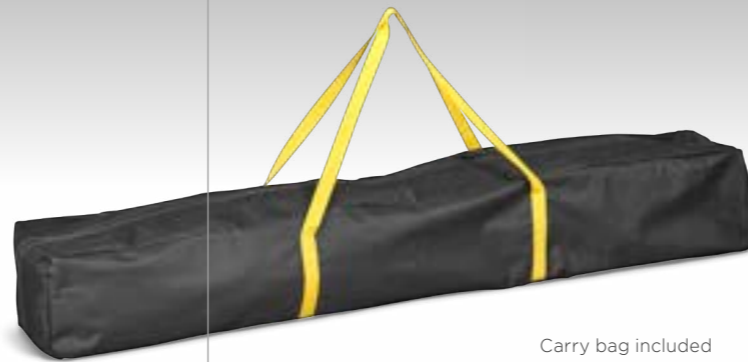
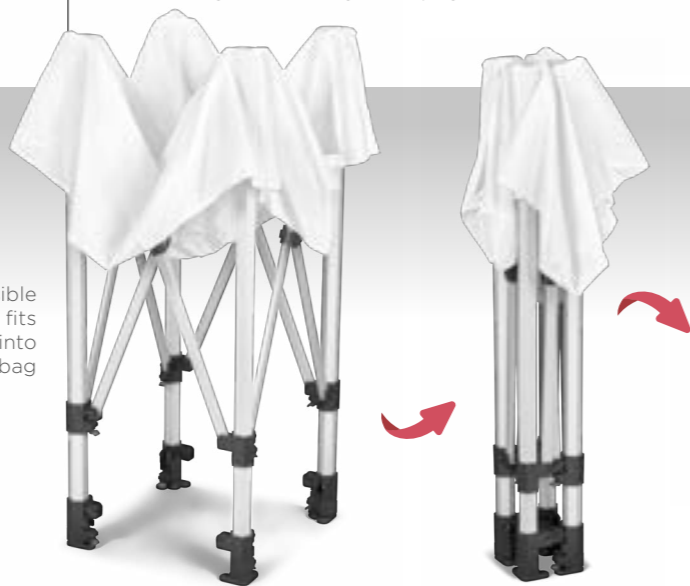

Carry bag included
(ALSO SOLD INDIVIDUALLY AS DISBAG-2020)



Toolkit included: 1 x mallet, 4 x ropes, 4 x frame pegs, 4 x rope pegs
(ALSO SOLD INDIVIDUALLY AS TOOLKIT-2000)

**FADE RESISTANT GAZEBO
2 X 2M**

SPECIFICATIONS

Weight: 14kg
Hardware: 1 x frame: aluminium, assembled size: 2 x 2m, quick assembly, portable
Slip over bag included: polyester oxford, size: 158 x 28 x 28cm, webbing handles
Toolkit included: 1 x mallet: rubber & wood, 4 x ropes: nylon, 4 x frame pegs: steel, 4 x rope pegs: steel
Fabric: print-guard polyester, water resistant
Branding: single-sided, latex gen-4 printing
Half wall visual size: 2 x 1m
Full wall visual size: 2 x 1.9m



WALL CONFIGURATION	DISPLAY CODE
No walls	VI-AM-194-D
1 x full wall skin	VI-AM-195-D
2 x full wall skins	VI-AM-196-D
3 x full wall skins	VI-AM-197-D
1 x half wall skin	VI-AM-198-D
2 x half wall skins	VI-AM-199-D
3 x half wall skins	VI-AM-200-D
4 x half wall skins	VI-AM-201-D
1 x full wall skin, 1 x half wall skin	VI-AM-202-D
1 x full wall skin, 2 x half wall skins	VI-AM-203-D
1 x full wall skin, 3 x half wall skins	VI-AM-204-D

Refresh the gazebo for multiple campaigns by buying a new skin	
Roof Reskin Code	GZ-AM-48-D
Full Wall Reskin Code	GZ-AM-49-D
Half Wall Reskin Code	GZ-AM-50-D



Collapsible gazebo fits easily into carry bag



Toolkit included: 1 x mallet, 4 x ropes, 4 x frame pegs, 4 x rope pegs

(ALSO SOLD INDIVIDUALLY AS TOOLKIT-2000)



Slip over bag included (ALSO SOLD INDIVIDUALLY AS DISBAG-2040)

BAG ON WHEELS FOR 2m GAZEBO SOLD INDIVIDUALLY AS DISPLAY-2001

Pitched roof gazebo, perfect for outdoor events and activations where a smaller footprint is required.



4 attached loops for additional stability, used to secure gazebo with ground pegs and ropes

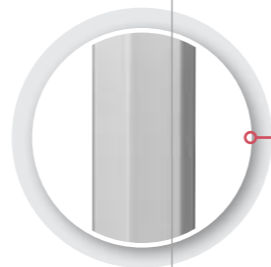

Aluminium hexagonal leg profile for superior strength



Pre-punched feet to easily secure gazebo with ground pegs

GAZEBO FOOTPRINT

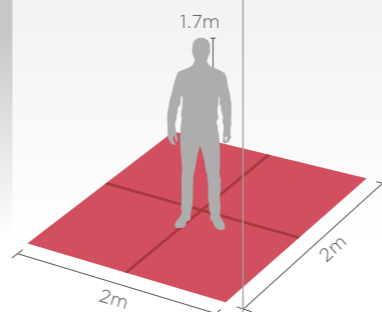

Image shown is for VI-AM-201-D

Branding is visible on one side only, walls can face inwards or outwards

**FADE RESISTANT GAZEBO
2 X 2M - PETITE FRAME**

SPECIFICATIONS

- Weight:** 13kg
- Hardware:** 1 x frame: aluminium, assembled size: 2 x 2m, quick assembly, portable, compact
- Slip over bag included:** polyester oxford, size: 122 x 28 x 28cm, webbing handles
- Toolkit included:** 1 x mallet: rubber & wood, 4 x ropes: nylon, 4 x frame pegs: steel, 4 x rope pegs: steel
- Fabric:** print-guard polyester, water resistant
- Branding:** single-sided, latex gen-4 printing
- Half wall visual size:** 2 x 1m
- Full wall visual size:** 2 x 1.85m



WALL CONFIGURATION	DISPLAY CODE
No walls	VI-AM-166-D
1 x full wall skin	VI-AM-164-D
2 x full wall skins	VI-AM-162-D
3 x full wall skins	VI-AM-160-D
1 x half wall skin	VI-AM-159-D
2 x half wall skins	VI-AM-158-D
3 x half wall skins	VI-AM-156-D
4 x half wall skins	VI-AM-154-D
1 x half wall skin, 1 x full wall skin	VI-AM-153-D
2 x half wall skins, 1 x full wall skin	VI-AM-151-D
3 x half wall skins, 1 x full wall skin	VI-AM-149-D

Refresh the gazebo for multiple campaigns by buying a new skin	
Roof Reskin Code	GZ-AM-48-D
Full Wall Reskin Code	GZ-AM-58-D
Half Wall Reskin Code	GZ-AM-50-D



(ALSO SOLD INDIVIDUALLY AS DISBAG-2140)



Toolkit included: 1 x mallet, 4 x ropes, 4 x frame pegs, 4 x rope pegs

(ALSO SOLD INDIVIDUALLY AS TOOLKIT-2000)

This gazebo is perfect for brand activations, product launches, sporting events and mobile retail shops to mention a few. The Petite Gazebo features extra collapsible legs that slide in making it compact and portable allowing for easy transportation.



4 attached loops for additional stability, used to secure gazebo with ground pegs and ropes

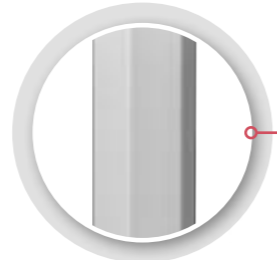

Aluminium hexagonal leg profile for superior strength



Pre-punched feet to easily secure gazebo with ground pegs



GAZEBO FOOTPRINT

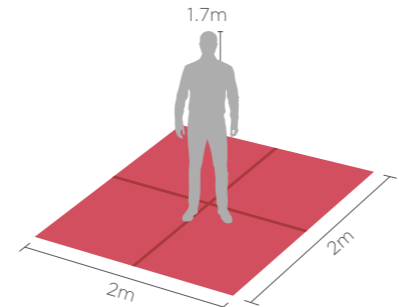

Image shown is for VI-AM-151-D

Branding is visible on one side only, walls can face inwards or outwards

FADE RESISTANT GAZEBO 3 X 3M

SPECIFICATIONS

- Weight:** 19kg
- Hardware:** 1 x frame: aluminium, assembled size: 3 x 3m, quick assembly, portable
- Slip over bag included:** polyester oxford, size: 158 x 28 x 28cm, webbing handles
- Toolkit Included:** 1 x mallet: rubber & wood, 4 x ropes: nylon, 4 x frame pegs: steel, 4 x rope pegs: steel
- Fabric:** print-guard polyester, water resistant
- Branding:** single-sided, latex gen-4 printing
- Half wall visual size:** 3 x 1m
- Full wall visual size:** 3 x 1.9m



WALL CONFIGURATION	DISPLAY CODE
No walls	VI-AM-205-D
1 x full wall skin	VI-AM-206-D
2 x full wall skins	VI-AM-207-D
3 x full wall skins	VI-AM-208-D
1 x half wall skin	VI-AM-209-D
2 x half wall skins	VI-AM-191-D
3 x half wall skins	VI-AM-190-D
4 x half wall skins	VI-AM-189-D
1 x half wall skin, 1 x full wall skin	VI-AM-187-D
2 x half wall skins, 1 x full wall skin	VI-AM-185-D
3 x half wall skins, 1 x full wall skin	VI-AM-183-D

Refresh the gazebo for multiple campaigns by buying a new skin

Roof Reskin Code	GZ-AM-51-D
Full Wall Reskin Code	GZ-AM-52-D
Half Wall Reskin Code	GZ-AM-53-D

With a slightly bigger footprint, this gazebo size is ideal for brand activations, product launches, sporting events and mobile retail to mention a few.



4 attached loops for additional stability, used to secure gazebo with ground pegs and ropes

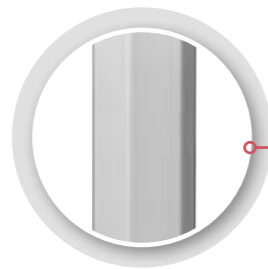

Aluminium hexagonal leg profile for superior strength



Pre-punched feet to easily secure gazebo with ground pegs



Image shown is for VI-AM-208-D

Branding is visible on one side only, walls can face inwards or outwards

GAZEBO FOOTPRINT

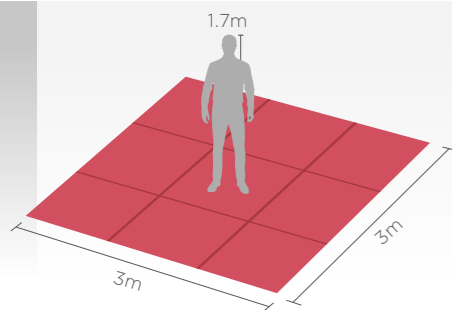

Collapsible gazebo fits easily into carry bag



Slip over bag included
(ALSO SOLD INDIVIDUALLY AS DISBAG-2040)



Toolkit included: 1 x mallet, 4 x ropes, 4 x frame pegs, 4 x rope pegs

(ALSO SOLD INDIVIDUALLY AS TOOLKIT-2000)



BAG ON WHEELS FOR 3m GAZEBO
SOLD INDIVIDUALLY AS DISPLAY-2001

**FADE RESISTANT GAZEBO
4.5 X 3M**

SPECIFICATIONS

- Weight:** 25kg
- Hardware:** 1 x frame: aluminium, assembled size: 4.5 x 3m, quick assembly, portable
- Slip over bag included:** polyester oxford, size: 158 x 29 x 31cm, webbing handles
- Toolkit included:** 1 x mallet: rubber & wood, 4 x ropes: nylon, 4 x frame pegs: steel, 4 x rope pegs: steel
- Fabric:** print-guard polyester, water resistant
- Branding:** single-sided, latex gen-4 printing
- Short half wall visual size:** 3 x 1m
- Long full wall visual size:** 4.5 x 1.9m
- Short full wall visual size:** 3 x 1.9m



WALL CONFIGURATION	DISPLAY CODE
No walls	VI-AM-182-D
1 x long full wall skin	VI-AM-181-D
2 x long full wall skins	VI-AM-180-D
1 x long full wall skin, 1 x short full wall skin	VI-AM-178-D
1 x long full wall skin, 2 x short half wall skins	VI-AM-176-D
1 x short full wall skin	VI-AM-175-D
2 x short full wall skins	VI-AM-173-D
2 x short half wall skins	VI-AM-171-D
1 x short half wall skin, 1 x long full wall skin	VI-AM-168-D

Refresh the gazebo for multiple campaigns by buying a new skin	
Roof Reskin Code	GZ-AM-54-D
Long Full Wall Reskin Code	GZ-AM-55-D
Short Full Wall Reskin Code	GZ-AM-56-D
Short Half Wall Reskin Code	GZ-AM-57-D

GAZEBO FOOTPRINT

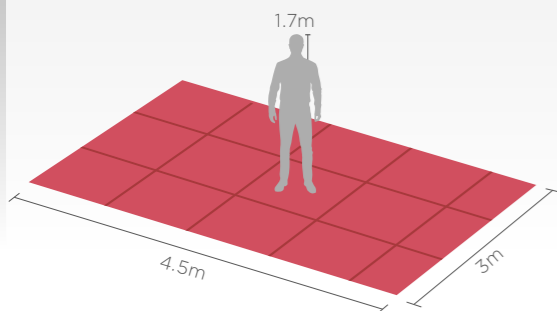

This gazebo has a slightly bigger footprint, accommodating for extra retail or display space. Perfectly fits 2 trestle tables under roof and big enough to fit 1 vehicle. That extra space might come in handy depending on the activation, product launch or event at hand.



4 attached loops for additional stability, used to secure gazebo with ground pegs and ropes

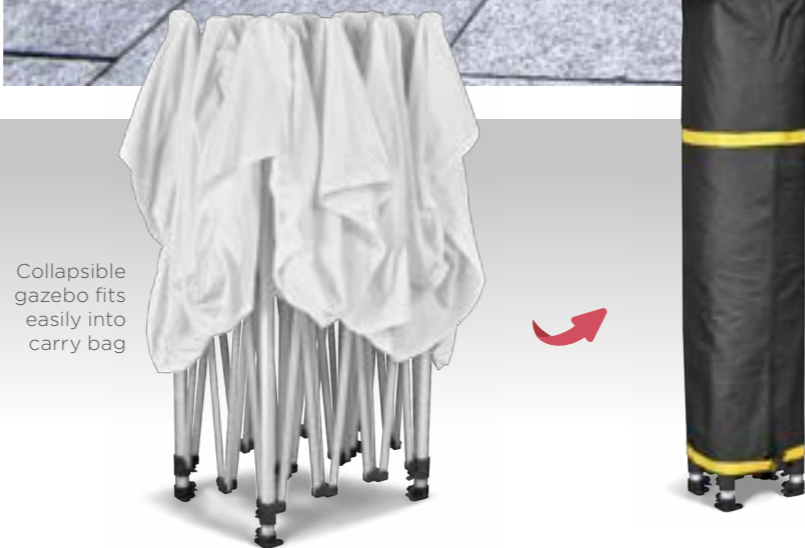

Collapsible gazebo fits easily into carry bag



Slip over bag included
(ALSO SOLD INDIVIDUALLY AS DISBAG-2080)

Toolkit included: 1 x mallet, 4 x ropes, 4 x frame pegs, 4 x rope pegs

(ALSO SOLD INDIVIDUALLY AS TOOLKIT-2000)

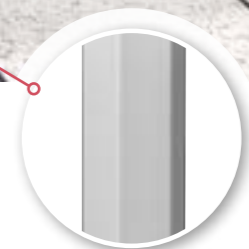

Aluminium hexagonal leg profile for superior strength



Pre-punched feet to easily secure gazebo with ground pegs

Image shown is for VI-AM-178-D

Branding is visible on one side only, walls can face inwards or outwards

**FADE RESISTANT GAZEBO
6 X 3M**

SPECIFICATIONS

- Weight:** 32kg
- Hardware:** 1 x frame: aluminium, assembled size: 6 x 3m, quick assembly, portable
- Bag included:** polyester oxford, size: 158 x 28 x 43cm, webbing handles
- Toolkit Included:** 1 x mallet: rubber & wood, 6 x ropes: nylon, 6 x frame pegs: steel, 4 x rope pegs: steel
- Fabric:** print-guard polyester, water resistant
- Branding:** single-sided, latex gen-4 printing
- Short half wall visual size:** 3 x 1m
- Long full wall visual size:** 6 x 1.9m
- Short full wall visual size:** 3 x 1.9m



WALL CONFIGURATION	DISPLAY CODE
No walls	VI-AM-147-D
1 x long full wall skin	VI-AM-150-D
2 x long full wall skins	VI-AM-152-D
1 x long full wall skin, 1 x short full wall skin	VI-AM-155-D
1 x long full wall skin, 2 x short half wall skins	VI-AM-157-D
1 x short full wall skin	VI-AM-161-D
2 x short full wall skins	VI-AM-163-D
2 x short half wall skins	VI-AM-165-D
1 x short half wall skin, 1 x long full wall skin	VI-AM-167-D

Refresh the gazebo for multiple campaigns by buying a new skin

Roof Reskin Code	GZ-AM-41-D
Long Full Wall Reskin Code	GZ-AM-42-D
Short Full Wall Reskin Code	GZ-AM-43-D
Short Half Wall Reskin Code	GZ-AM-44-D

GAZEBO FOOTPRINT

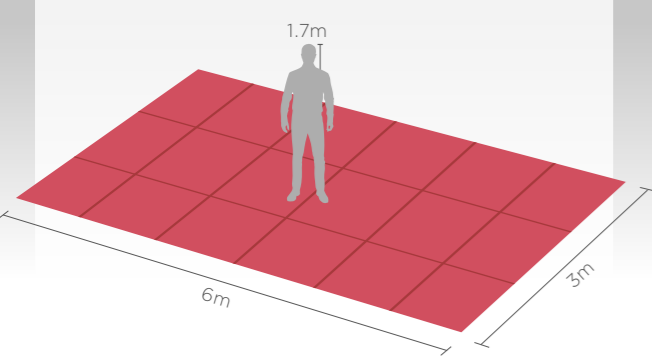

Collapsible gazebo fits easily into carry bag

From outdoor events to corporate functions, this lightweight gazebo is the perfect display solution. It is fully collapsible and easy to setup, not mention fully customisable in terms of the number of walls and branding options. Branded Gazebos are a popular and affordable means of advertising.



4 attached loops for additional stability, used to secure gazebo with ground pegs and ropes



Slip over bag included
(ALSO SOLD INDIVIDUALLY AS DISBAG-2010)

Toolkit included:
1 x mallet, 6 x ropes,
6 x frame pegs, 6 x rope pegs
(ALSO SOLD INDIVIDUALLY AS TOOLKIT-2010)

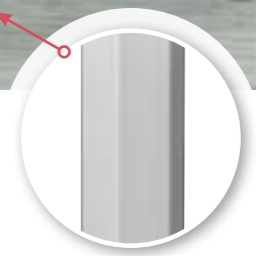

Aluminium hexagonal leg profile for superior strength



Pre-punched feet to easily secure gazebo with ground pegs

Image shown is for VI-AM-150-D

Branding is visible on one side only, walls can face inwards or outwards



DISPLAY

YOUR BRAND, ANYWHERE
